





LUCA @ CAHA Schmidt

Project overview

Rev. No.	Document authors / contributors	Approval	Date
1	F. Prada, E. Pérez, R. Content, J. Lawrence, G. Murray, J.M. Ibáñez, J. Sánchez, E. Sánchez, S. Tulloch, R. García-Benito, L. Izzo, E. Pérez Montero	 Francisco Prada	3 May 2019
2	F. Prada, E. Pérez	 Francisco Prada	28 May 2019

Principal Investigator: Francisco Prada
f.prada@csic.es



Outline

1. Introduction
2. Team and Collaborators
3. LUCA Science at the CAHA Schmidt telescope
4. Instrument overview
5. Project Layout: work packages
6. Project schedule and costs
7. Competition beyond 2020: SDSS-V Local Volume Mapper
8. Appendix A: AAO trade-off spectrograph study for the Calar Alto Schmidt telescope
9. Appendix B: Winlight 1-arm spectrograph for Schmidt telescope Study and first spectrograph



LUCA_RPT_001 LUCA@Schmidt

Audentes fortuna iuvat.

Publio Virgilio, Eneida, 10, 284.

Ex nihilo nihil fit.



1. Introduction

This document has been produced under the request of the Director of the IAA for his decision to provide the necessary resources to move forward with the completion of the LUCA spectrograph construction at the Schmidt telescope and the signature of the required MoU CAHA-IAA that will guarantee the access to the Schmidt telescope at Calar Alto during the 3-year (good weather) duration of the project.

The document presents a complete overview of the LUCA Project at the Calar Alto Schmidt telescope. The work included in this report has been performed over the past 2 years by a team of engineers/scientists at the IAA-CSIC and other institutions/consultants, in close contact with the CAHA staff. We provide specifications, requirements, science cases, description of the different instrument systems, optical layout, performances and design, expected schedule and costs.

The revised version of this document includes a very recent Winlight spectrograph proposal for the Schmidt, in addition to that from the AAO, and a new section of exposure times and survey speed for LUCA@Schmidt.

This document (LUCA_RPT_001) should be read and understood within the larger context of the LUCA Project at the CAHA 3.5m telescope.

2. Team, Collaborators and Acknowledgements

The work presented in this report has been performed over the past 2 years by our LUCA Team at the IAA-CSIC in collaboration other institutions, and in close contact with the CAHA staff.

LUCA Team IAA-CSIC:

Francisco Prada, *Principal Investigator, Project Manager, Instrument Scientist*
Enrique Pérez, *Project Scientist*
Justo Sánchez, *Electronic Engineer*
José Miguel Ibáñez, *Software Engineer*
Ernesto Sánchez, *Optical Consultant*

Collaborators:

Graham Murray (Durham University), *Fiber System and Slit Assembly*
Simon Tulloch (QUCAM), *Detector System*
Robert Content and Jon Lawrence (AAO), *Spectrograph System*
CAHA staff: Gilles Bergond (*Observatory Contact*), Luis Hemández (*Electronic Engineer*),
Santiago Reinhart (*Mechanical Engineer*)

Acknowledgements:

We thank María Balaguer, Head of UDIT, for her comments and recommendations on different aspects of the Project Management and AIV; Rubén García Benito, Luca Izzo, and Enrique Pérez Montero for useful discussions and their contribution to Sec. 3 on LUCA Science at the CAHA Schmidt telescope, Izaskun San Román for the JPLUS M33 image, and Johan Comparat for help with the ETC.

3. LUCA science at the CAHA Schmidt telescope

The Local Group galaxies M31 and M33 have huge angular sizes (3° and 1.2° angular diameter) that far exceed the $5'$ mean angular size of the galaxies in the main LUCA sample. If we attempt to fully map them with the proposed IFU instrument (FoV $3' \times 3'$) at the 3.5 m, both galaxies would absorb an unreasonable amount of observing time. However, these galaxies are fundamental in our understanding of the structure and evolution of galaxies, as shown by the exhaustive literature published over a century, and largely constitute the overall success of the LUCA Project. M31 and M33, together with the Milky Way, are the main players in the Local Group, and they also give the highest spatial resolution, 25 pc, of the LUCA galaxy sample. The technical features of the Schmidt telescope provide the adequate technical requirements and time availability to make it an efficient facility for an IFU mapping of those two galaxies, plus M101. This will be possible only with the new wide FoV IFU spectrograph proposed in this report for the Schmidt telescope at Calar Alto.

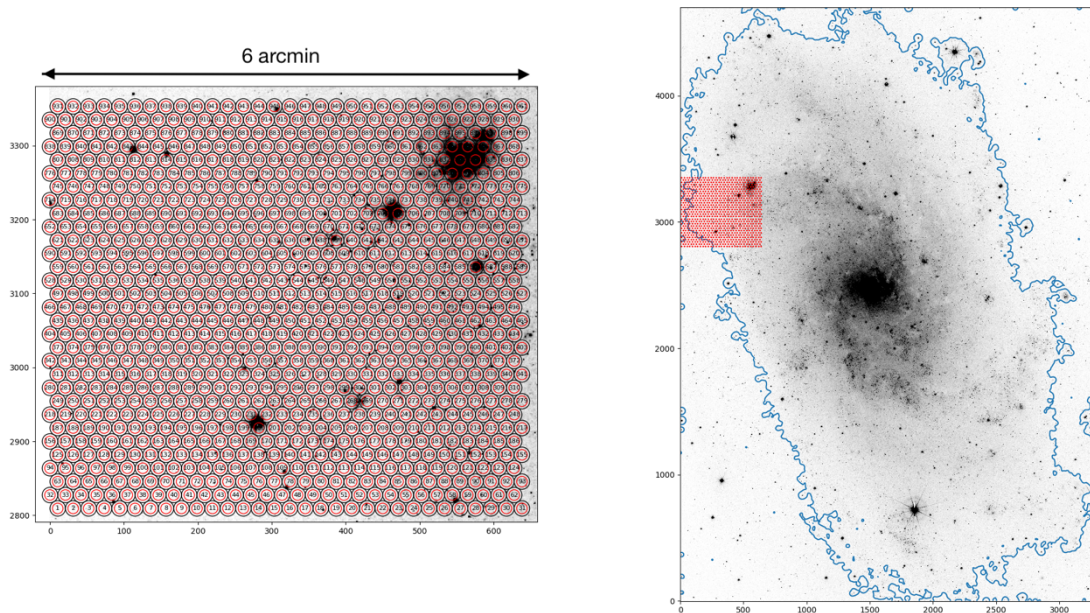

The figure shows one fiber bundle IFU pointing on M33 including the giant HII region NGC604 in the top left hand side. A total of about >800 fibers can be accommodated side by side for a fiber core of 100 micron ($8''$) and total fiber diameter (including clad, buffer, and tolerance) of 150 micron ($12.93''$). In a squared arrangement as shown, this provides a FoV = $6' \times 6'$, and a total of 25-50 pointings are needed to cover M33 entirely.

To meet the science goals a new fiber-fed spectrograph will be attached to the 80 cm Schmidt telescope which will allow observing in the optical spectral range 360-880 (360-680) with resolution 4000 (2000). The IFU will have a unique wide FOV of $6' \times 6'$ with >800 fibres, each of $8''$ aperture on the sky which corresponds to 25 pc physical scale in M31 and M33.

First light at the telescope is foreseen for June 2021, which will guarantee the IFU mapping observations of M31/M33 over the Autumn 2021 semester. Thus, science data will be granted before the end of the IAA Severo Ochoa Project as required.

The science cases listed below represent a summary of the main science program of the LUCA Project to be done at the Schmidt telescope:

- 3.1 Hierarchical structure in the Pan-Andromeda Archaeological Survey
- 3.2 Star formation and remnant studies at high spatial resolution
- 3.3 2D Photoionization models of HII regions
- 3.4 Studies of HII regions and dust
- 3.5 Galaxy formation: the reversed radial stellar age gradient in the outskirts of M33
- 3.6 Transient studies in M31 and M33
- 3.7 Resolved stellar populations in M31

3.1 Hierarchical structure in the Pan-Andromeda Archaeological Survey

The Pan-Andromeda Archaeological Survey (McConnachie et al. 2018) is a survey of 400 square degrees centered on the Andromeda (M31) and Triangulum (M33) galaxies. A dozen of distinctive substructures were detected and produced by at least 5 different accretion events, all in the last 3 or 4 Gyrs. A few of the substructures furthest from M31 may be shells from a single accretion event. M31's halo seems to be dominated by two "mega-structures" that can be considered as the two most significant branches of a merger tree produced by breaking M31's stellar halo into smaller and smaller structures. One of the streams could in fact be associated primarily with M33's halo (see figures below). The LUCA@CAHA Schmidt spectral data cubes will contribute to understanding the formation of the Pan-Andromeda system.

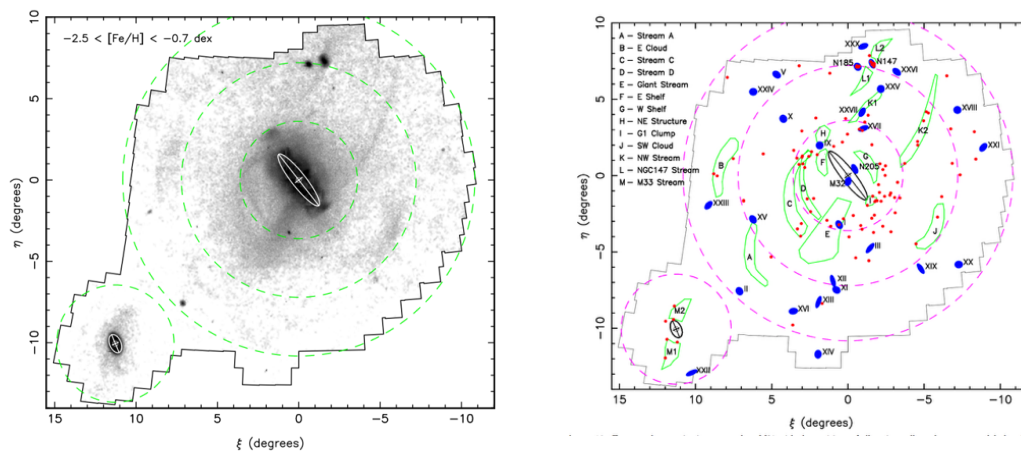

M31 spatial density distribution of candidate red giant branch stars. The dashed circles correspond to projected radii of 50kpc, 100kpc, and 150kpc from M31, and 50 kpc from M33.

Tangent plane projection centered on M31 with the positions of all major stellar substructures, globular clusters and dwarf galaxies highlighted. (McConnachie et al. 2018)

3.2 Star formation and remnants studies at high spatial resolution

White et al. (2019) have performed new 1.4 GHz and 5 GHz observations of the Local Group galaxy M33 with the Jansky Very Large Array. The survey has a limiting sensitivity of $20 \mu\text{Jy}$ and a resolution of $5.9''$ (FWHM), corresponding to a spatial resolution of 24 pc. This map offers a unique opportunity for the comparison at the same spatial resolution with our planned LUCA IFU spectroscopy of M33 at the Schmidt telescope.

The panel below, taken from White et al. (2019), shows a $4.4'$ by $10.7'$ region of the southern spiral arm in M33. The top panel is the color radio spectral index map. Locations for optically detected SNRs are shown as white ellipses; many can be identified by cross-referencing to the middle panel that shows a three-color image of continuum-subtracted emission line data, with H α in red, [SII] in green, and [OIII] in blue. The bottom panel is a continuum-subtracted H α image. The green overlay shows radio contours from the 1.4 GHz data. Red crosses mark the positions of radio sources from their catalog in this region. Some of the complexity of making associations between radio sources and either HII regions or SNRs can be seen here. This can be studied in detail with LUCA. Some of the complexity of making associations between radio sources and either HII regions or SNRs can be studied in detail with LUCA.

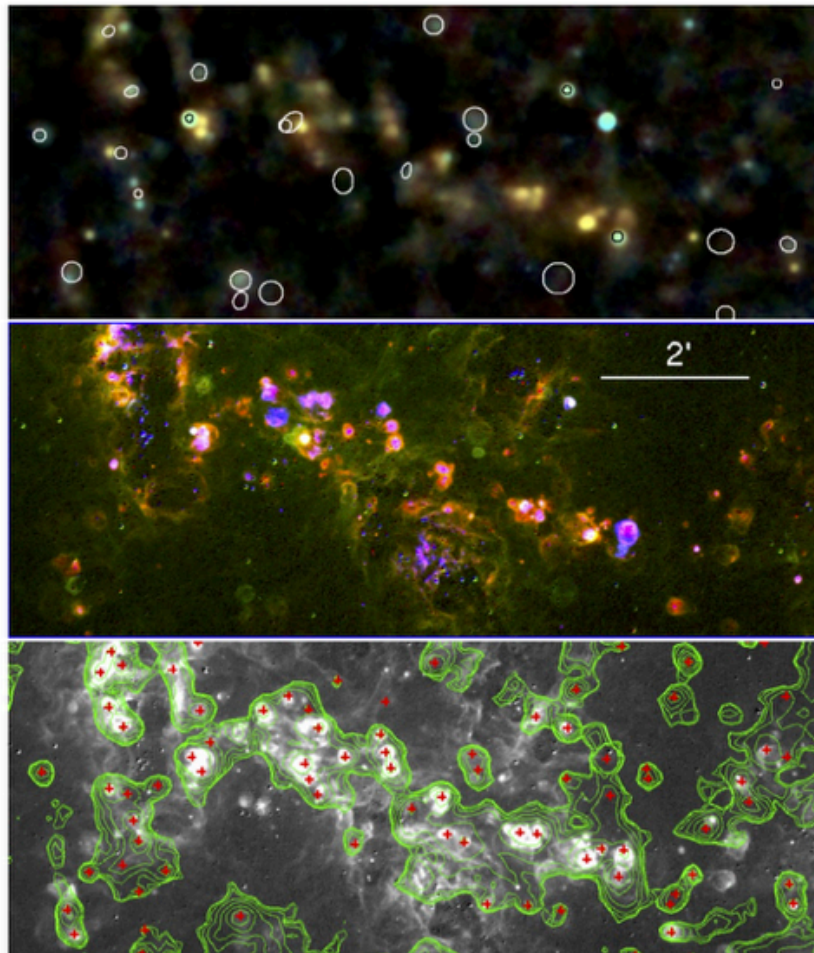

3.3 2D Photoionization models of HII

2D IFU maps of the main optical emission lines (from [OII] 3727 up to [SII] 6731) complementing available IR data from Herschel ST will help to constrain 3D photoionisation models and provide answers to the radial distribution of metallicity, nature of the ionising clusters, dust-to-gas mass ratio, depletion factors, and fraction of escaping photons in the whole disk of resolved galaxies, such as M31 and M33.

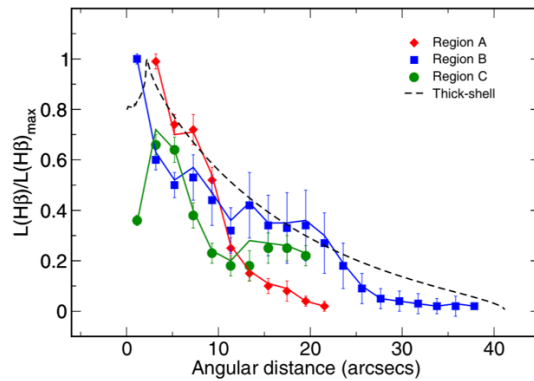
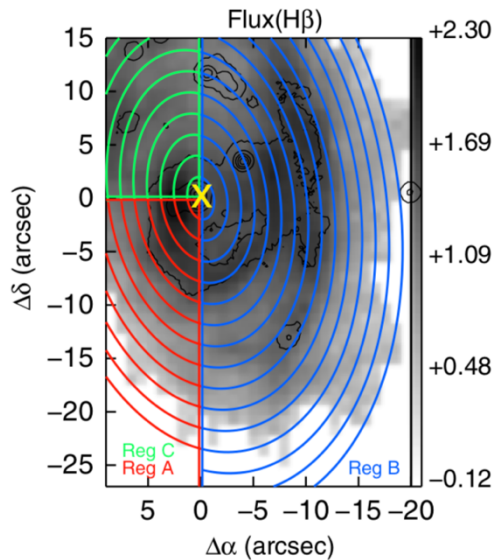

NGC 588 @M33 (4 arcsec width annuli from mosaic of PMAS) Pérez-Montero et al. (2014).

3.4 Studies of HII and dust

Optical IFU maps of nearby galaxies enable to: (i) resolve HII regions, (ii) reveal and resolve the diffuse ionized gas, (iii) map dust within galaxies.

M33 is ideal because: (i) high (25 pc) spatial scales, (ii) low metallicity environment, (iii) existing extensive multi-wavelength coverage, (iv) high (50pc) resolution CO maps (Rosolowsky et al 2007).

Thus enabling studies of HII regions and dust at the spatial scales relevant for understanding the physics of star formation.

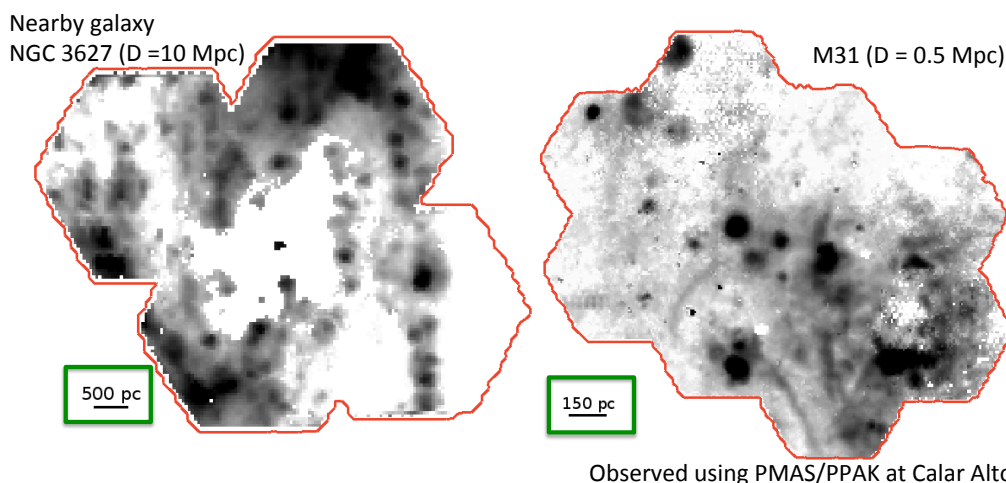

Observed using PMAS/PPAK at Calar Alto

Kreckel et al (2013), using 12 loci adding up to 3'x3' field PPAK data from 3.5m@CAHA show that galaxies observed at ~500pc scales do not obey a simple foreground screen model for extinction, while in M31, with 10 pc resolution the extinction is well modelled by a simple screen. Similar data by Tomičić et al 2017 and 2019 shows the importance of high spatial resolution to understand the mixed role of dust and DIG; and find that star formation rate prescriptions in M31 do not change with spatial scales 10 - 900 pc.

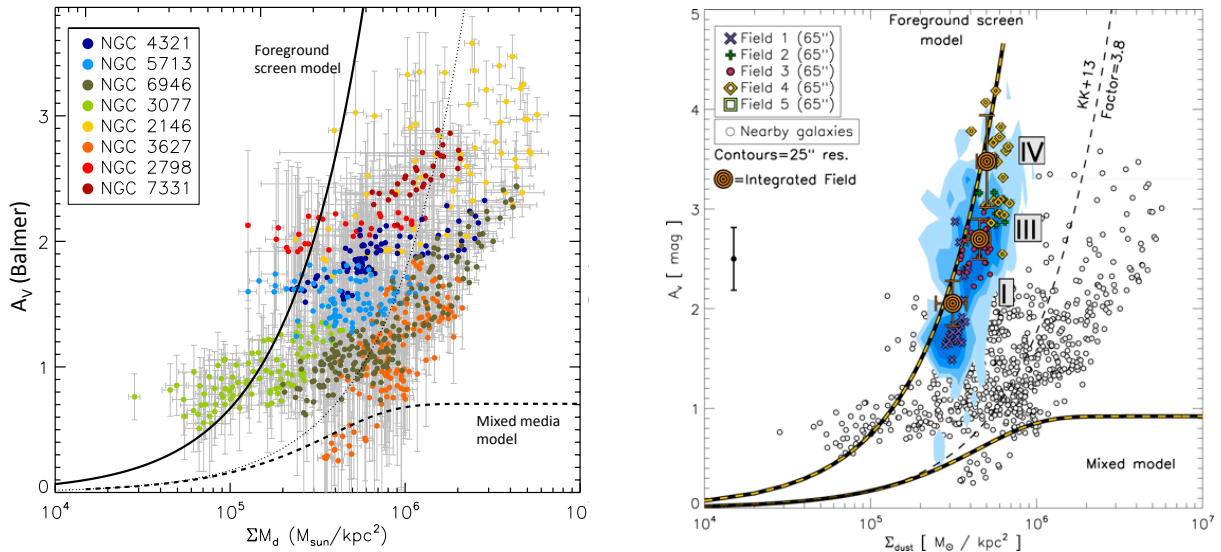

Kreckel et al (2013) (left) and Tomičić et al (2017) (right) results for dust extinction.

3.5 Galaxy formation: the reversed radial stellar age gradient in the outskirts of M33

HST/ACS observations along the major axis of M33 show that the mean age of its stars decreases with increasing distance from the galaxy center. Such a behavior is consistent with an inside-out growth of the disc. However, in the outermost observed field, at $r \approx 11.6$ kpc, a reversal of this gradient is detected, with old stars found in high percentages beyond this radius. LUCA at the CAHA Schmidt offered a unique opportunity to confirm this fundamental results which is key to understand galaxy formation. The LUCA 3D data cubes will also serve as a challenge to probe the results of hydro-dynamical cosmological models of M33 in this context. See the figures below with some of the predictions and results highlighted.

The LUCA M33 data will also be unique to determine the nature of dark matter by means of providing a constraint for the dark matter density profile. This will be determined from the modelling of the observed kinematics of gas and stars. M33 is an ideal case this is study since it is a disk only galaxy and very nearby.

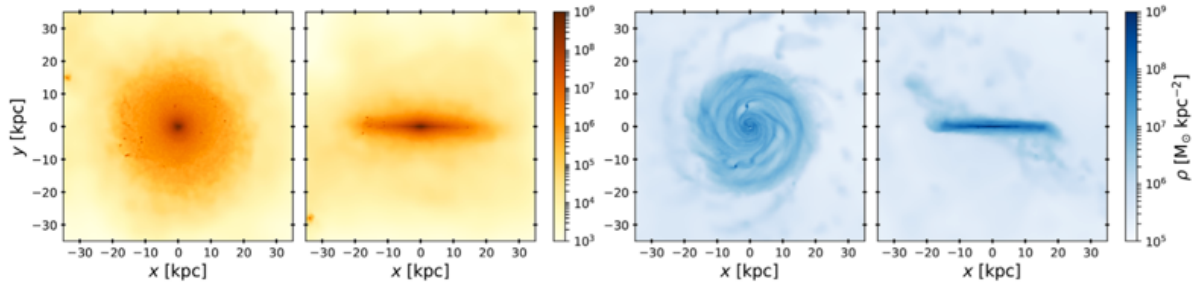

Stellar (left) and gas (right) mass densities of the simulated M33 galaxy at $z=0$.

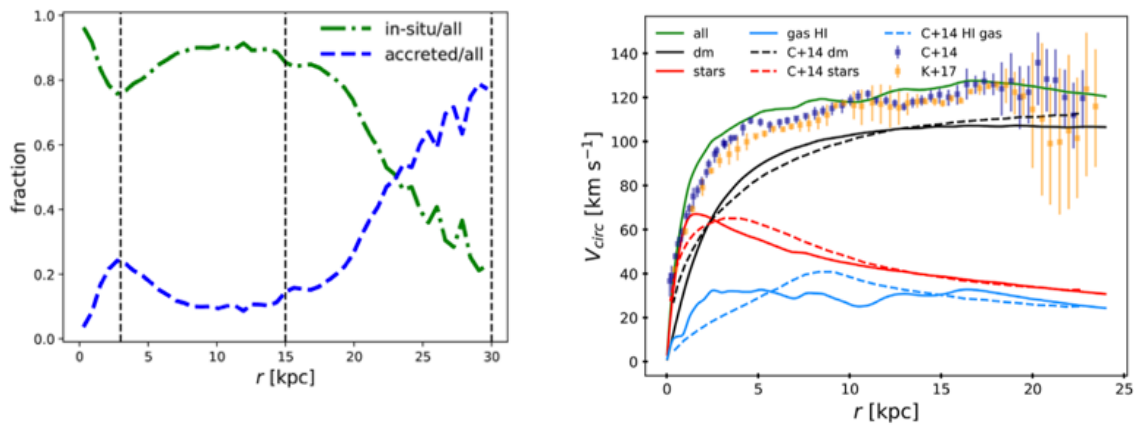

(left) Fraction of in situ and accreted stellar particles within radial bins for M33 at $z=0$. The in situ stars made up $\sim 80\%$ of the total stellar mass within $r=15$ kpc while at 30 kpc it decreases to $\sim 20\%$. The stars accreted via mergers increase with radius causing the age-reversal observed at large radii. (right) Circular velocity profiles of DM halo (black), stars (red), and HI gas (blue) of the simulated M33 (solid lines) compared with observations from Corbelli et al (2014) (dashed).

3.6 Transient studies in M31 and M33

Detection and characterisation of classical novae in M31 and M33. Two main scientific cases:

- (i) Nova rate and their relation with SN Ia progenitor (SDD or DD) and stellar population.
- (ii) The role of CNe as factories of chemical elements in these galaxies.

The chart below summarises the aspects of the detection and characterisation of novae in M33.

CN rate in M31 & M33

Detection and characterisation of novae

- *determination of the unknown nova rate*
M31: 50 -100 yr⁻¹ - M33: 1 -20 yr⁻¹ (???)

Arp (1955), Rosino (1973), Shafter & Irby (2010)

- *search for "fast and faint" novae*
discovered with the P60 telescope + IFU
time decay ~ 1 day

Kasliwal+ (2011)

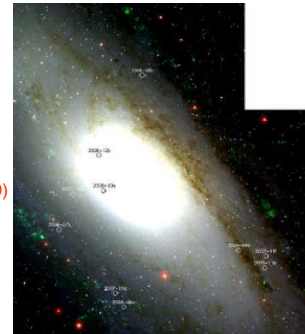
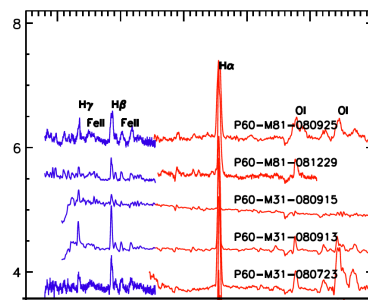

IFU detectors are perfect to provide position and immediate spectroscopy of fast transients !!!

The main results of the novae populations and nucleosynthesis are outlined in these two panels:

NOVAE & STELLAR POPULATIONS

the exact determination of nova rate will provide important information on their role as SN Ia progenitor and their stellar population

dependence of the rate on the stellar population:

- M31 -> two distinct populations (disk+bulge like MW)
- M33 -> younger stellar populations, less massive galaxy wrt M31

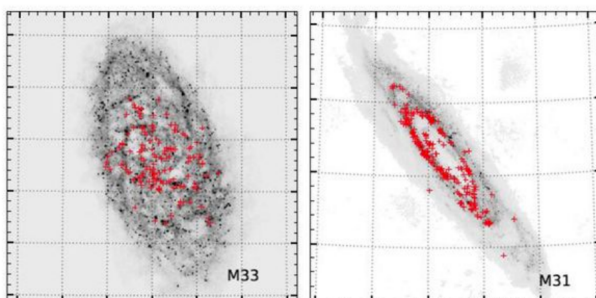

NUCLEOSYNTHESIS

Novae are important factories of CNO isotopes and of lithium
Gehrz+ (2008), Izzo+ (2015)

They explain the over-abundance of lithium in younger stellar populations

Nova rate vs SN rate and their distribution in the host galaxy

1 SN Ia every 100 yrs

~1.4 MSun of material ejected in the host galaxy at a fixed location

100 novae yr⁻¹
single ejecta of 10⁻⁴ MSun
x 100 years

~1 MSun distributed inside the host galaxy

3.7 Resolved stellar populations in M31

Main scientific questions:

- Is the Star Formation History derived using CMD techniques similar to the fossil-record SFH?
- M31 is the perfect candidate for this bench test
- Complete M31 IFU mapping will address this and other many issues:
- Abnormal Balmer ratios, benchmark for studies of the stochastic interface for stellar populations techniques, Planetary Nebulae hunter (origin of M31 substructures), ...

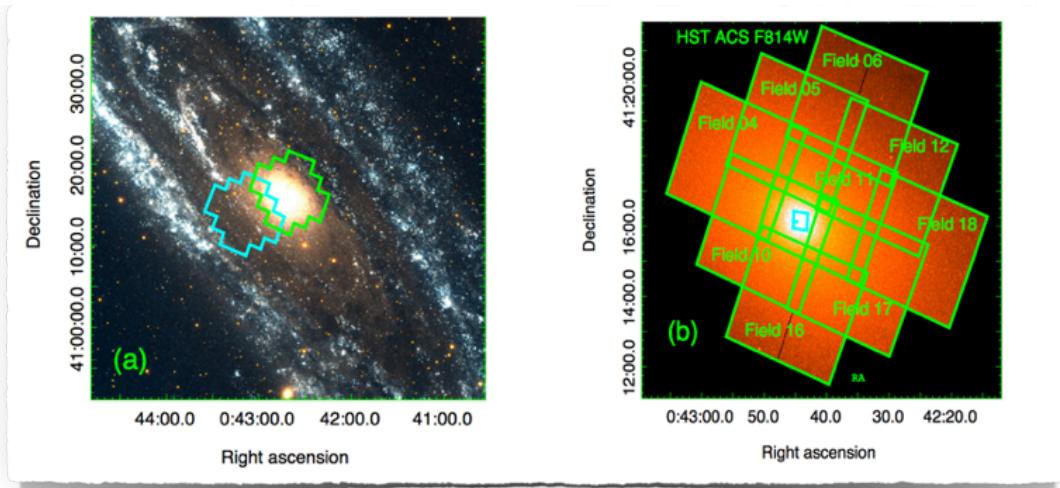

M31 with PMAS (Dong et al. 2018)

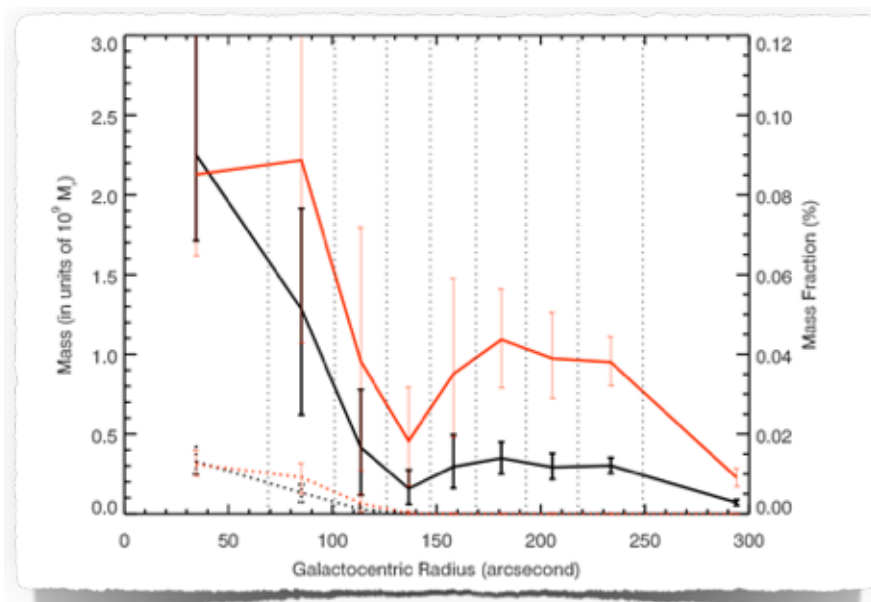

At later times, the star formation rate decreased and then experienced a significant rise around 1 Gyr ago, which pervaded the entire M31 bulge. After that, stars formed at less than 500 Myr ago in the central 130 arcsec. The secular evolutionary process still continuously builds up the M31 bulge slowly.

4. Instrument overview

A schematic view of the LUCA instrument at the CAHA Schmidt telescope:

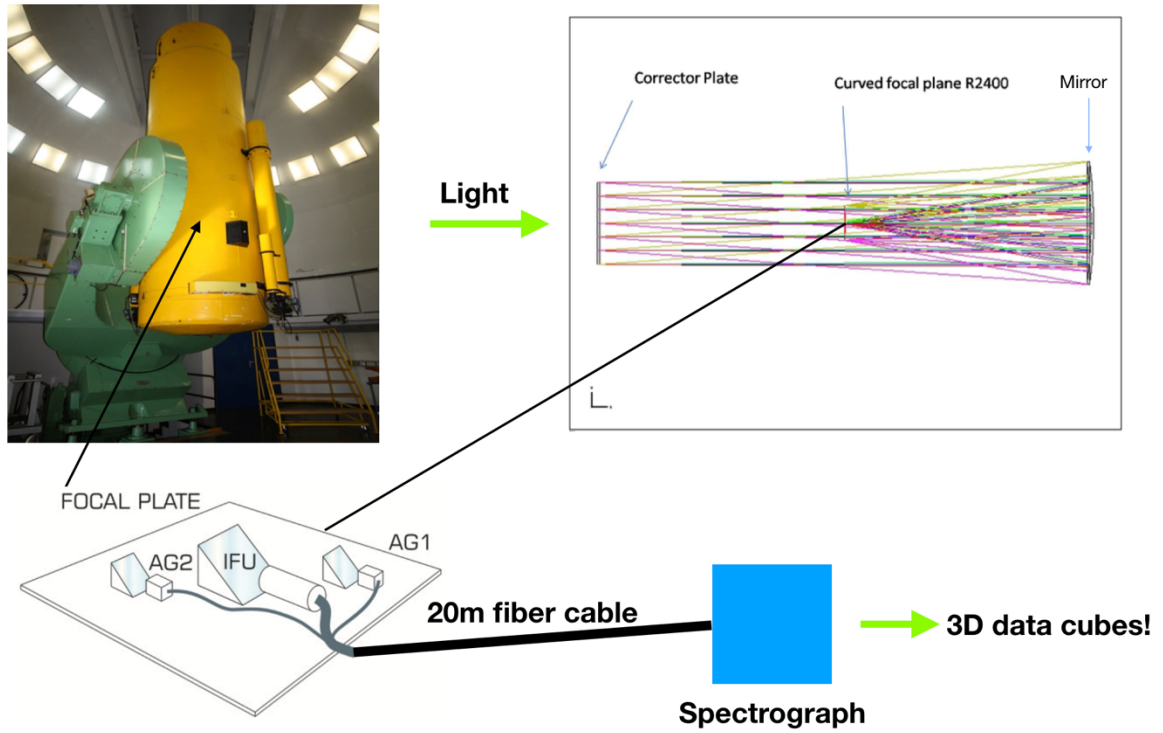

We describe below each of the instrument systems, including the Schmidt telescope.

(A) Schmidt telescope

The Schmidt telescope was originally located at the Hamburg Observatory since 1955 and later installed at Calar Alto Observatory in 1980 by the Max-Planck-Institut für Astronomie, Heidelberg. The corrector plate and mirror have 80 cm and 120 cm diameter respectively; the focal length is 240 cm and the focal ratio $f/3$. A field-of-view of 8° (335 mm) diameter is available with a plate scale of $86.2''/\text{mm}$. See a digitalized image of M31 below. More details on the telescope can be found in Birkle et al. (1994).

aperture	mm	800
focal length	mm	2400
f/ratio		1/3
FOV	$^\circ$	8
	mm	335
plate format	inch	8 x 10
scale	$''/\text{mm}$	86.2

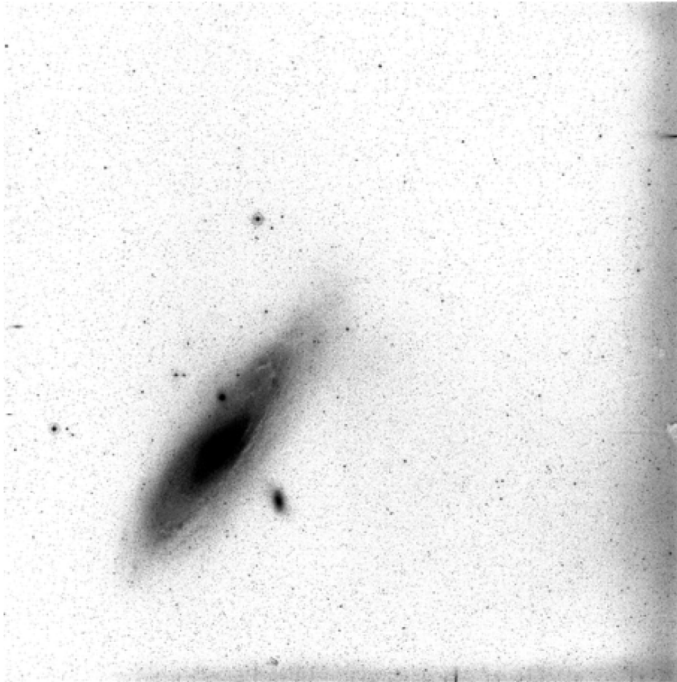

A digital image of $5.5^\circ \times 5.5^\circ$ of the M31 field photographed on a Kodak 24 cm x 24 cm curved plate using the Schmidt telescope at Calar Alto (credit: HDAP).

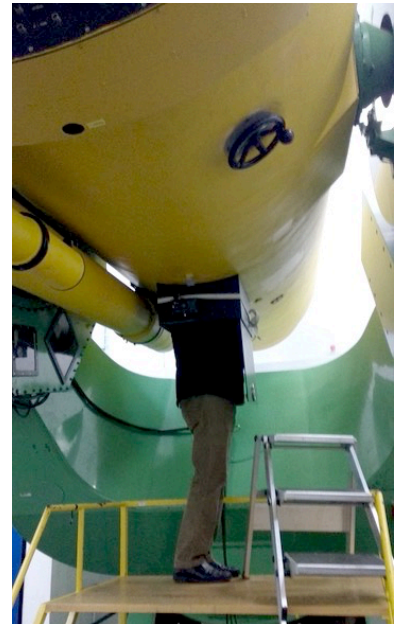

Our colleague J. Sánchez inspecting the focal plane assembly.

Our Team has been in close contact with the CAHA staff to follow up their upgrade of the telescope control and had several visits and meetings to evaluate the assessment of the LUCA needs and specifications for the Focal Plane Assembly, specifications and logistics at the Schmidt telescope. We have also made a Zemax optical model of the Schmidt telescope using the original paper drawings. This was necessary to perform the optical design of the spectrograph.

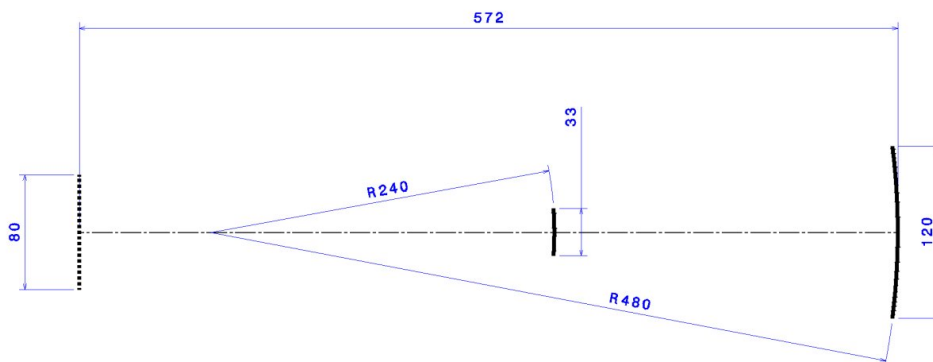

Sketch of the optical elements of the Schmidt telescope.

The distance from corrector ($\varnothing 80$ cm) to primary mirror ($\varnothing 120$ cm) is 572 cm
 FOV = 8° or 33.5 cm diameter
 Focal = F3 or aperture angle of $\approx 19^\circ$
 Distance primary to focal plane = 240 cm
 Radius of curvature primary = 480 cm
 Radius of curvature focal plate = 240 cm

Schmidt Corrector: the first optical element is 80 cm diameter lens in UBK/Schott glass. UBK7 is like the standard BK7, but extended to 300 nm to the UV (BK7 goes to 350 nm). The infrared cut is at 1500 nm for both glasses. Thus transmission is guaranteed from 300 nm to 1500 nm.

The second optical element is a 120 cm diameter concave spherical mirror, the primitive radius of curvature of this sphere is 480 cm. It has no central hole. The reflectance layer is made in aluminum with good transmission from 350 nm to 1500 nm.

(B) Focal Plane Assembly

The nominal Focal Plane is a spherical circular cap (sphere radius 240 cm) of 33,5 cm diameter. Light rays arrive perpendicular to this cap. In the past the Schmidt was used with square photographic plates of 24cm side; the glass photo plate must be curved in order to replicate the nominal sphere curvature.



The focus mechanism had three parts:

- A. a **moving part** (containing the cassette), width ≈ 9 cm
- B. a **fixed part** that contains the motors to focus, width ≈ 8 cm
- C. a **baffle structure** that support the two previous parts and it is attached to the spider plate, width ≈ 9 cm

Now A has been removed.

The IFU will be placed at the Focal Plate. We consider two solutions:

- On-axis solution. The ideal solution is to put the IFU on the optical axis at the center of the Focal Plate, which implies folding of the fiber bundle perpendicular to the optical axis.
- Off-axis solution. To work in IFU mode at the Schmidt another possible solution is to take advantage of the current retractable system of putting the “photographic plates”, and install the IFU perpendicular to the optical axis of the telescope with a mirror at 45° on that axis to receive the light. In this way we can put other mirrors at 45° to bend the light to a coherent fiber bundle.

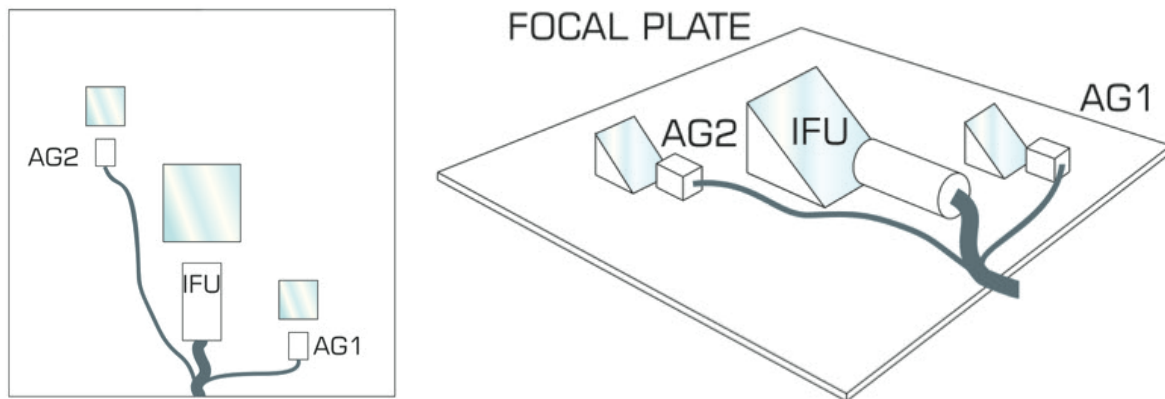

Frontal and lateral view of the LUCA Focal Plate at the Schmidt telescope. The plate size is 12 cm x12 cm.

We believe that the off-axis solutions offer many advantages. See above a schematic view of the Focal Plate.

(C) Fiber system

The fiber system consists of four main components:

- 20 m fiber cable
- IFU with >800 fibers
- Fiber connector
- Slit assembly
- IFU cross-talk simulations
- The LUCA spectrograph system
- Detector system

Below we provide a description.

C.1. 20 m fiber cable

Cutaway view showing the composition of a stranded cable. “Miniflex” segmented furcation tubes containing science fibres are stranded around a central tensile element. Fill factor, cable diameter, stranding pitch are all optimised for minimum fibre stress. Cables are produced by Durham University in collaboration with a UK company inventors of the Miniflex tube.

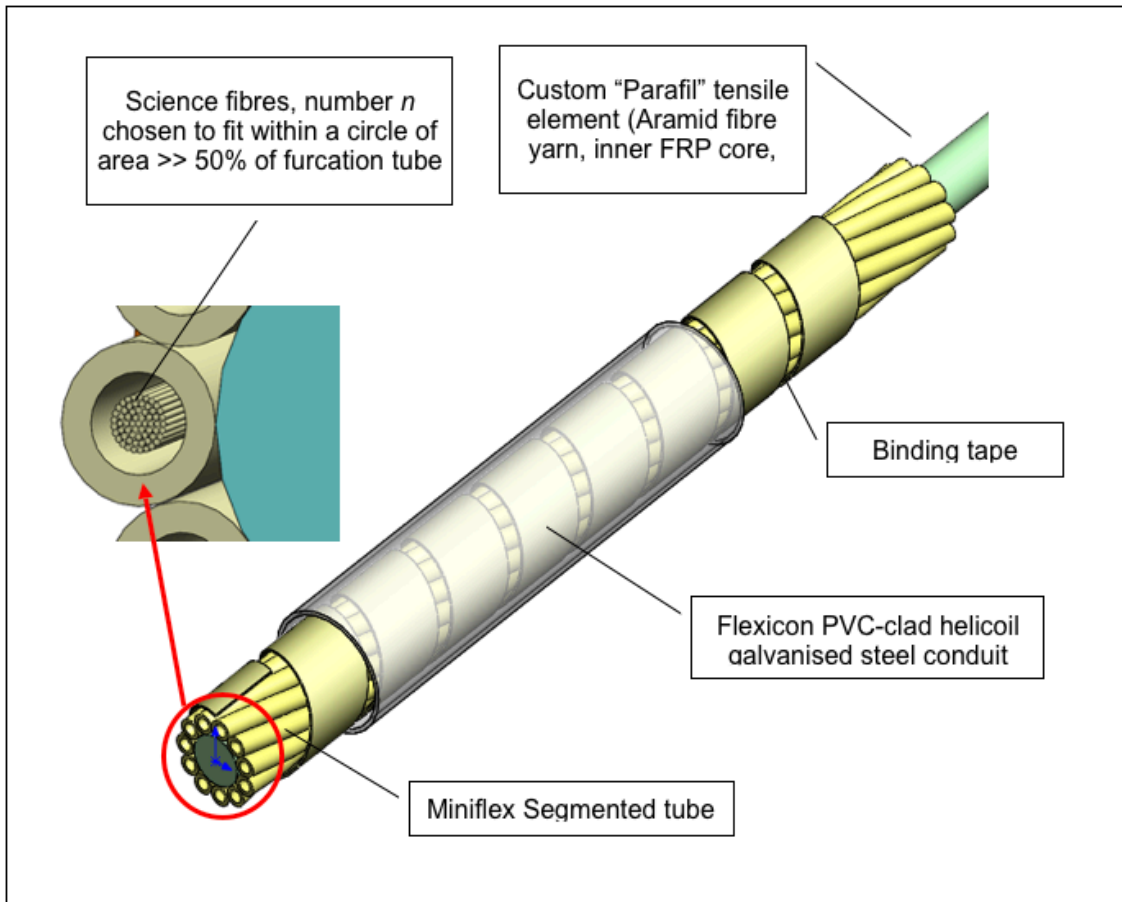

The fibre feed scheme for channeling fibre into the Miniflex extrusion line. Introducing the fibre during the production of the Miniflex tube results in a highly parallel lay and minimal tensile stress. Fibres are first drawn through a boron nitride powder coating bath to apply a uniform and continuous coat of the dry powder lubricant. This minimises any stress due to friction, and prevents fibres sticking together and sticking to the inner wall of the tube as it is formed.

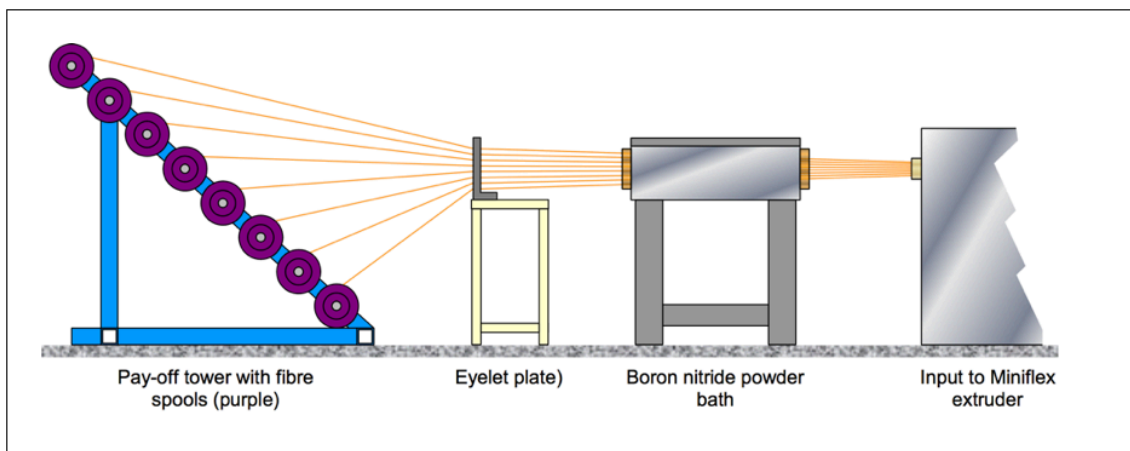

In the figures below we show some pictures.

(Left) Spools of fibre loaded onto the pay-off structures. (Right) A set of ceramic eyelets guides the fibres from the pay-off and into an agitation bath of boron nitride powder, which coats the fibres before they pass through into the Miniflex tube extruder.



The cable production line, starting with the tensile element on the right. This feeds into a planetary strander which carries spools of Miniflex furcation tubes containing the fibres. The tubes are wound around the tensile element in planetary-fashion (no twist). The stranded cable is then bound with consolidating tape, resulting in a stranded and tape-bound cable emerging on the left. The haul-off pulls cable through the production line at a constant rate and maintains tension.

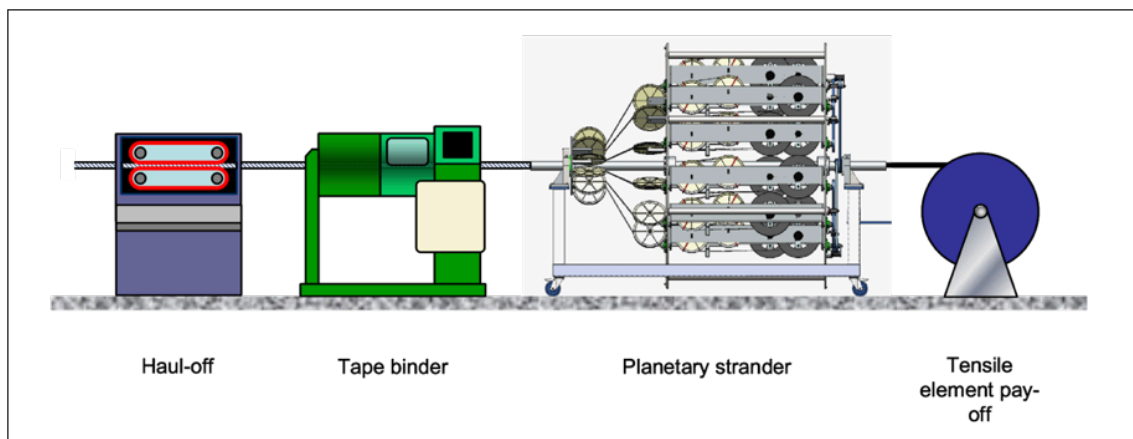

The production line, set up and ready to begin cable manufacture. The inset photos bottom right show stranded cable coming off the line; (left) the cable emerges from the machine, (right) the cable after tape binding.



Anticlockwise from top right: More pictures of the strander and the production line, finished cable core, putting the cable core into conduit.

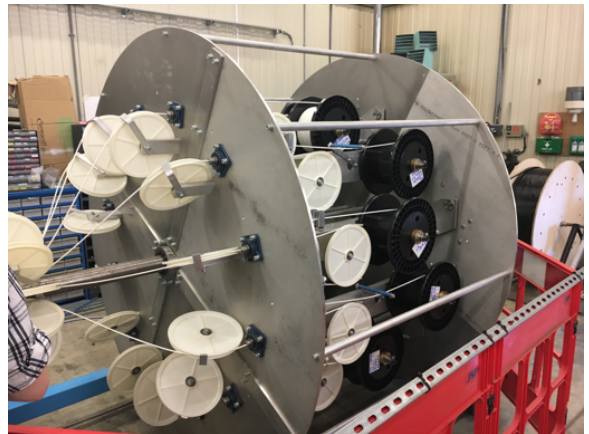

C.2. IFU with more than 800 fibers

MaNGA-style IFU input using tapered ferrule, bare fibres in direct contact. Suitable for schemes without microlenses. The IFU manufacturing for LUCA relies on the experience of the Durham University.

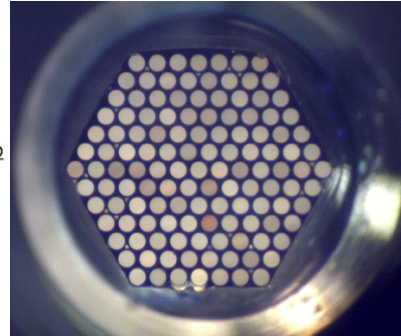
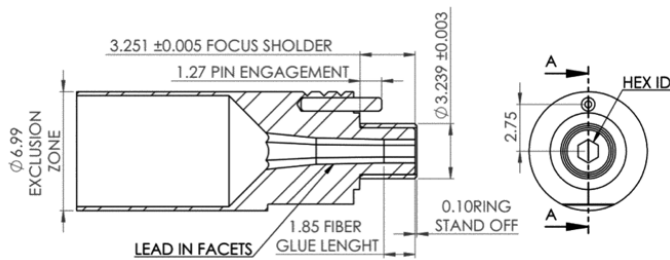

Examples of IFU 2-D fibre array inputs using hole arrays. Suitable for schemes with microlenses only because sparse distribution of fibres means low fill factor.

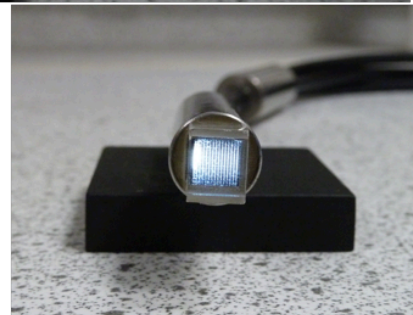
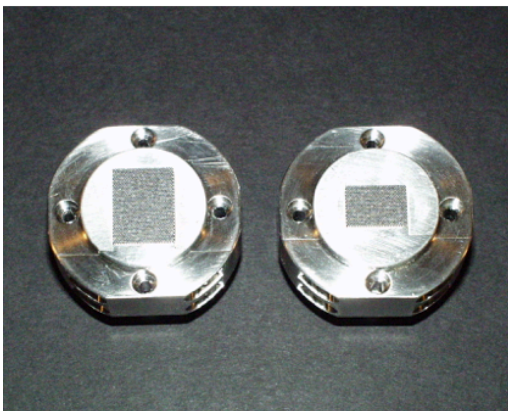
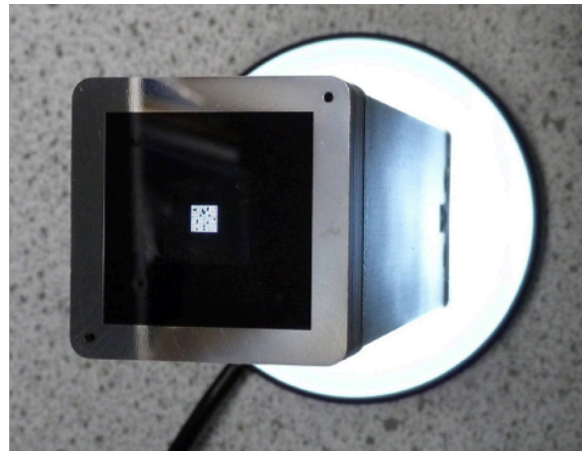
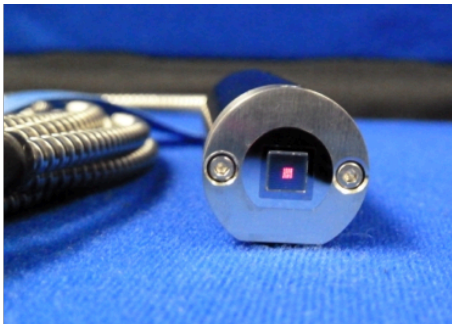

Transmission of two candidate fibers (Polymicro FBPI and FPI) superposed with a nebular spectrum for reference. The two wavelength ranges corresponding to different spectrograph designs extend to 685 (saturated color) and 880nm (light color).

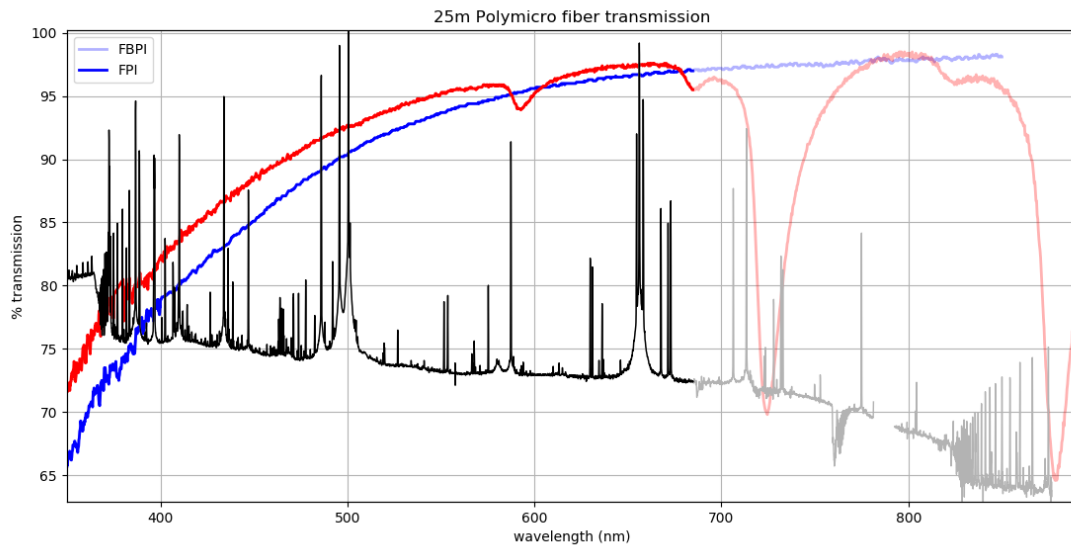

C.3. Fiber connector

We propose a connector to facilitate the logistics. It will connect the fiber cables from the telescope Focal Plate (17 m) and the spectrograph slit (3 m).

Glenair MIL Spec high efficiency fibre connector. A modular connector builds up of floating-mount, individually spring-loaded pins. Fibres are bonded in white zirconia ferrules on the ends of the pins. Photo below shows an example of this connector type assembled by SQS.



C.4. Spectrograph Slit Assembly

Slit Units have been made in Durham for many instruments – fibre arrays with large fibre counts, from simple parallel schemes (top right) to complex, curved / non-telecentric / off-axis geometries. Details are shown in the figure below. Top-left: Single FMOS slit unit, showing construction formed from individual blocks. Bottom-left: Two FMOS slit units, showing construction formed from individual blocks. Bottom-right: Two FMOS slit units, showing construction formed from individual blocks.

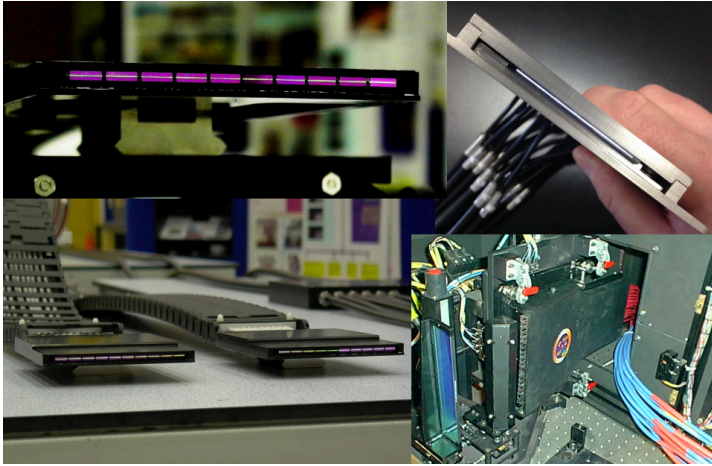

We propose for LUCA at the Schmidt telescope a monolithic V-groove slit design – a prototype concept done at Durham University based on Subaru PFS slit geometry; see below.

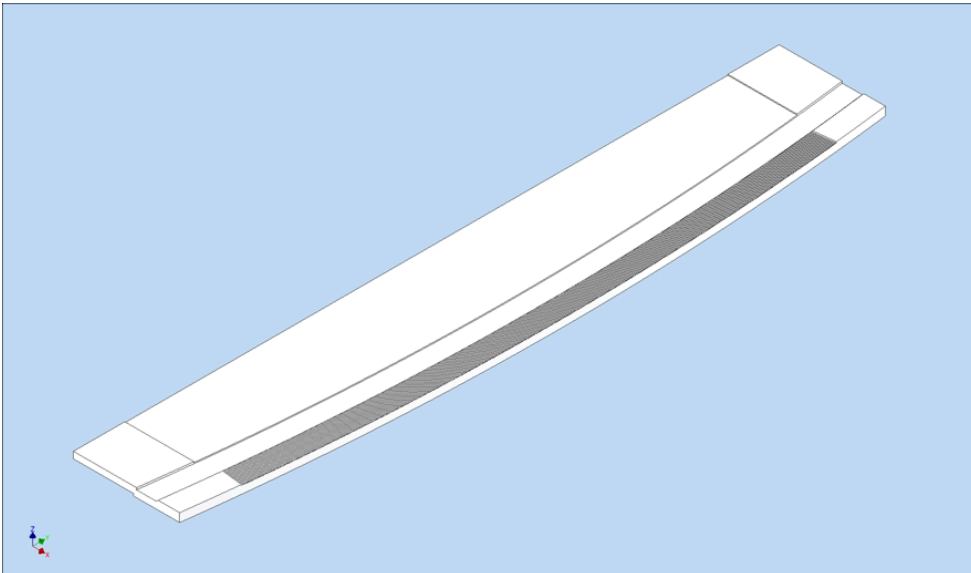

The monolithic v-groove array prototyped to the PFS design is shown below. Cut from a single piece of borosilicate glass, this v-groove array exhibits extremely high tolerances, high thermal stability, low profile (< 3 mm height). This solution will improve the spectrograph performance as compared to the classical pseudo-slits, as shown above where groups of 50-109 fibers are put together along the slit.

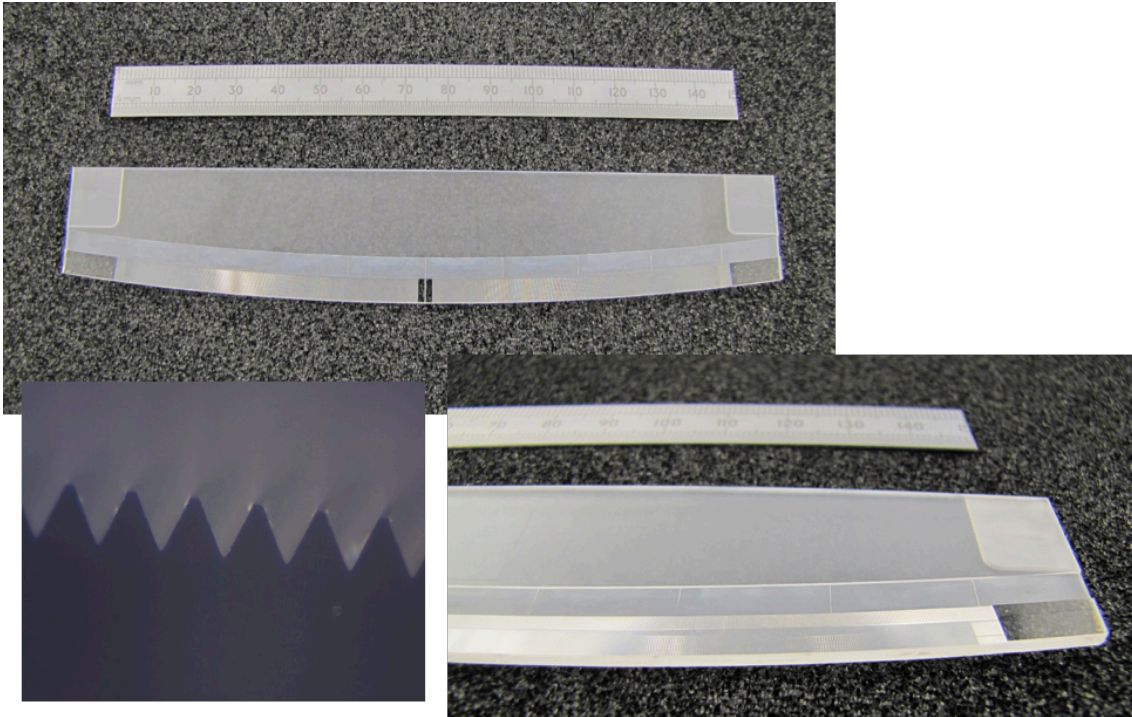

C.5. IFU cross-talk simulations

A single IFU pointing (cf. figure above of single pointing on M33) generates a spectral-spatial 2D image in the detector, with fibers arranged along the spatial direction. A slice of this image along the spatial direction is shown on the top plot of the enclosed image, with a zoomed in shown in the insert, where the single fiber PSF can be seen. A PSF model (e.g., a Gaussian) is fitted to each

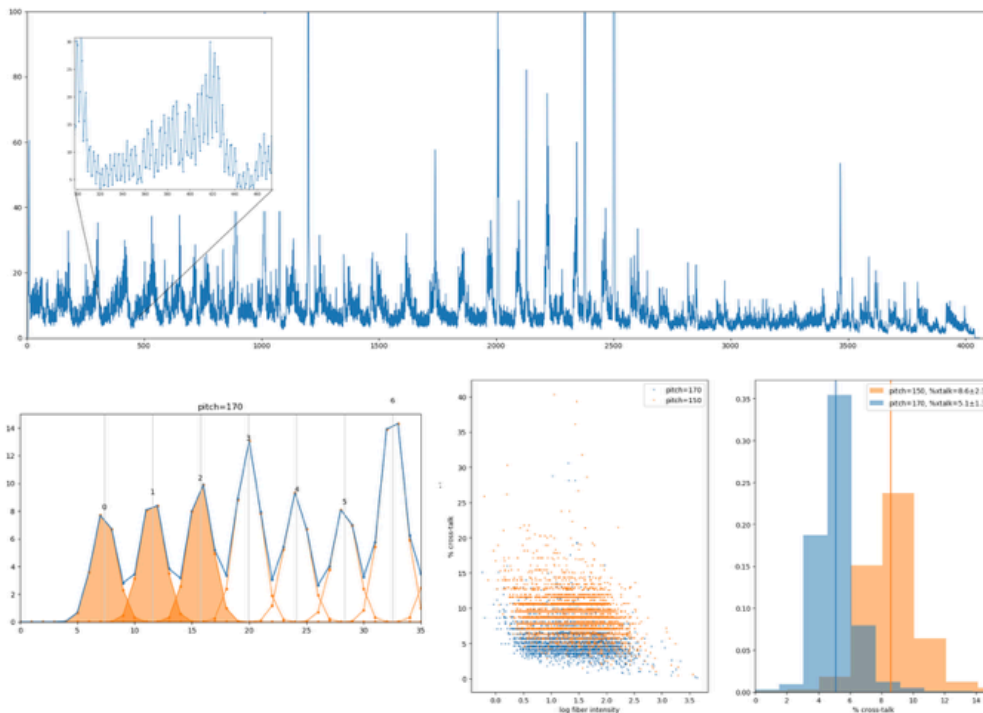

fiber PSF as shown in the bottom-left figure (in orange in the figure), and the cross-talk is defined as the fraction of the PSF that falls below neighbouring fibers (darker orange wings). The two bottom-right figures give the values of cross-talk extracted for two different values of the fiber pitch at slit (the peak-to-peak separation of fibers along the slit) with values of 150 and 170 micron.

C.6. The LUCA Spectrograph system

To meet the science goals we require building a new spectrograph that will allow observing in the optical spectral range 360-880 (360-680) with resolution 4000 (2000). The IFU will have a unique wide FOV of 6' x 6' with >800 fibres, each of 8" aperture on the sky, which corresponds to 25 pc physical scale in M31 and M33.

Our collaborators at the AAO have performed a trade-off study between 4 options for LUCA at the CAHA Schmidt telescope. Jon Lawrence, Head of Technology of the Australian Astronomical Observatory (AAO), visited the IAA on Feb. 18-19. Jon spent his time in Granada to work with our group on the progress of the AAO feasibility study of LUCA at CAHA 3.5 m telescope. He also discussed with us the proposal of the AAO spectrograph, design by Robert Content, for the LUCA spectrograph at the Schmidt. He also met with the IAA director.



Four AAO options for LUCA at the CAHA Schmidt telescope:

1. Option 1 (SPH). This design was developed based on the motivation to replicate as far as practical the Hector spectrograph design with minor variations.



2. Option 2: Option 1 blue arm only (SPH_blue). This option includes the blue arm only for option 1. This design is upgradable in the future to include the red arm.
3. Option 3: Option 1 lite (SPH_lite). This design was based on scaling down the size of the SPH spectrograph so that it matches the efficiency of the DESI spectrograph. Note for this option it is likely that further savings could be made by e.g., removing lenses or aspheres or changing glass type or continuing the optimisation.
4. Option 4: Schmidt_LUCA (SL). This design is based around the specifications for the LUCA project. It has a single arm only with reduced wavelength coverage and resolution.

Table below gives the main parameters for the 4 AAO options. In addition, we are also including the new one arm spectrograph recently developed by Winlight (hereafter “Winlight 1-arm”) as the result of their design proposal for LUCA at the 3.5m CAHA telescope. It is important to note that this new spectrograph design is not a copy of an existing spectrograph, and hence there will be no conflict with intellectual property (see Appendix B).

Parameter	Winlight 1-arm	Option 1 - SPH	Option 2 – SPH blue	Option 3 – SPH lite	Option 4 – SL
Wavelength coverage (nm)	365-730	360-580 + 560-880	360-560 (580)	360-580 + 560-880	360-685
Spectrograph arms	1	2	1	2	1
Resolution arm 1	2140-3600	2670-4230	2670-4230	2750-4350	1750-3330
Resolution arm 2	NA	2950-4640	NA	3010-4730	NA
Input element on-sky aperture (100 μ m fibre)	6.84"	7.91"	7.91"	6.84"	8.4"
Output f/ratio fore-optics	f/3.85	f/3.33	f/3.33	f/3.85	f/3.13
Input f/ratio collimator	f/3.57	f/3.26	f/3.26	f/3.77	f/3.07
Fibre core diam (pixels)	3.17	2.85	2.91	2.84	2.80
As-designed PSF (RMS micron)	10	9.7	9.7 (12.7)	8.7	12.5
Max number of fibres	784	990	990	800	910
Overall figure of merit	1.07	2.10	1.00	1.30	1.08

Parameters for each AAA option relative to the new Winlight option.

More details can be found in Appendices A and B for the AAO and Winlight designs.

We provide a chart for each of the options with the IFU FoV. Note that AAO Option 2 has the same FoV of Option 1. We also show a representative number of positions needed for each option to map M33 completely.

Option 1 - SPH

360-580 nm + 560-880 nm

100 μ core = 7.91" on sky
 fiber core projects on 2.85 CCD pixels
 # fibers < 990
 Slit length = 145.2 mm
 Fiber pitch 147 μ

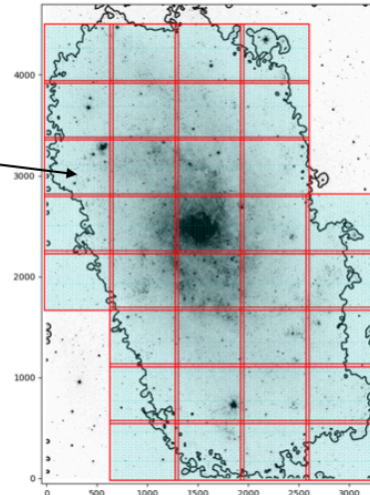
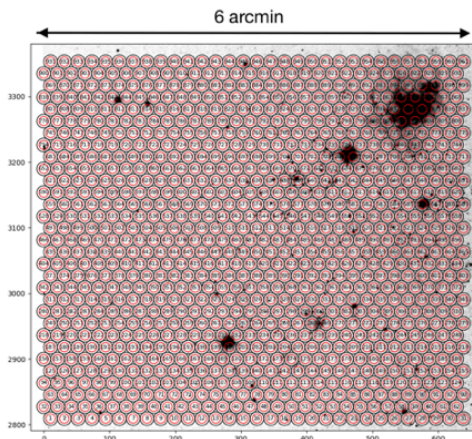
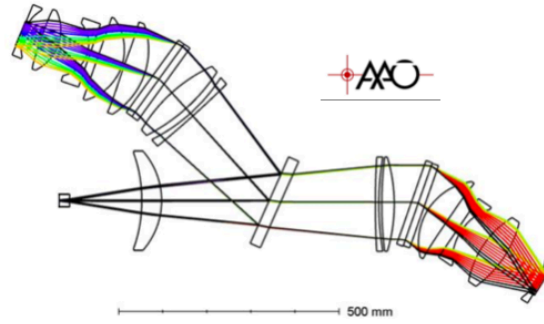

29 loci

Option 3 - SPH Lite

360-580 nm + 560-880 nm

100 μ core = 6.84" on sky
 fiber core projects on 2.84 CCD pixels
 # fibers < 800
 Slit length = 115.0 mm
 Fiber pitch 144 μ

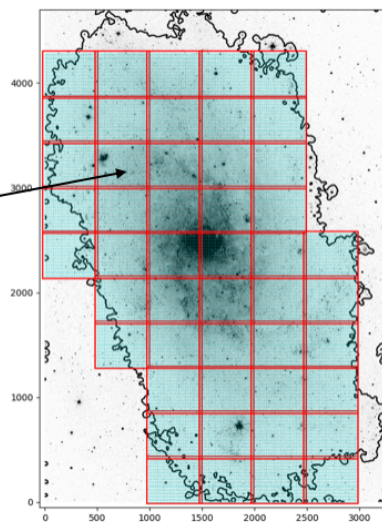
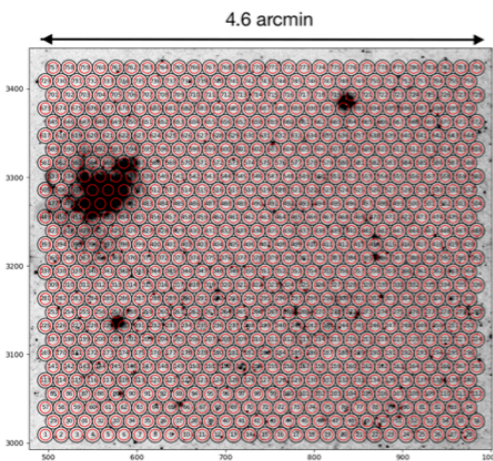
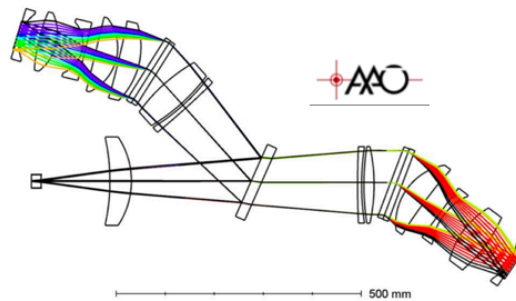

48 loci

Option 4 - SL

360-685 nm

100 μ core = 8.4" on sky
 fiber core projects on 2.80 CCD pixels
 # fibers < 910
 Slit length = 145.2 mm
 Fiber pitch 160 μ

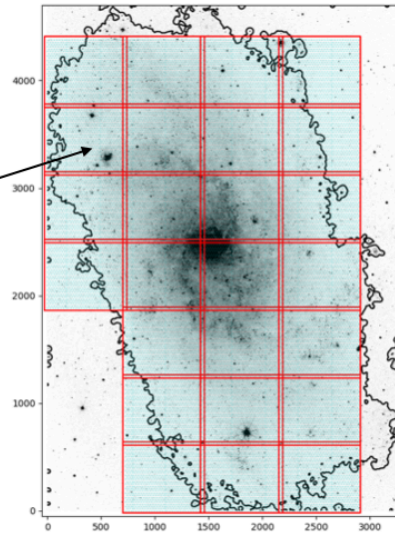
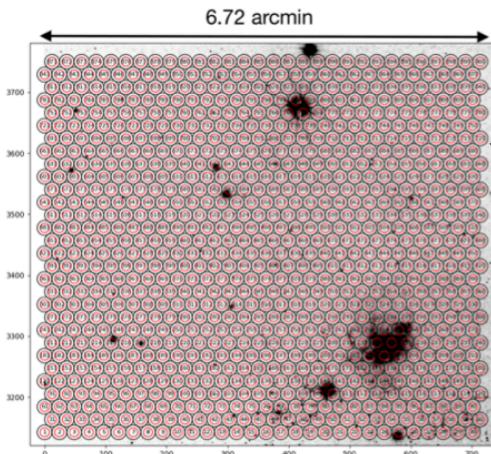
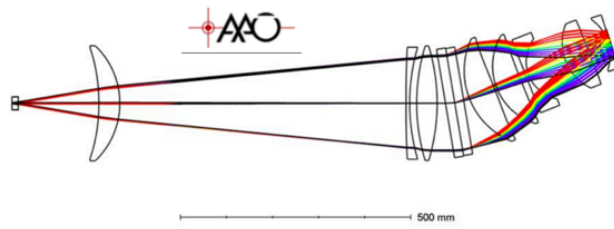

25 loci

Option Winlight

365-730 nm

100 μ core = 6.84" on sky
 fiber core projects on 3.17 CCD pixels
 # fibers < 784
 Slit length = 121.0 mm
 Fiber pitch 147 μ

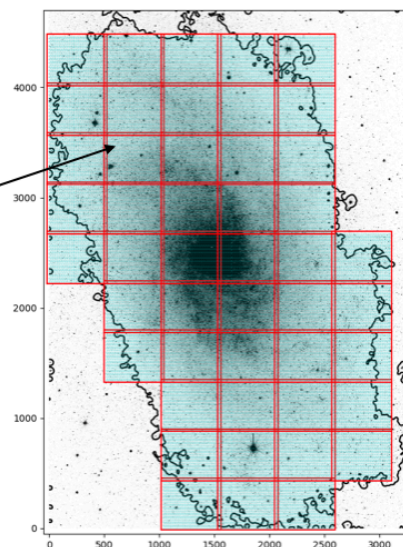
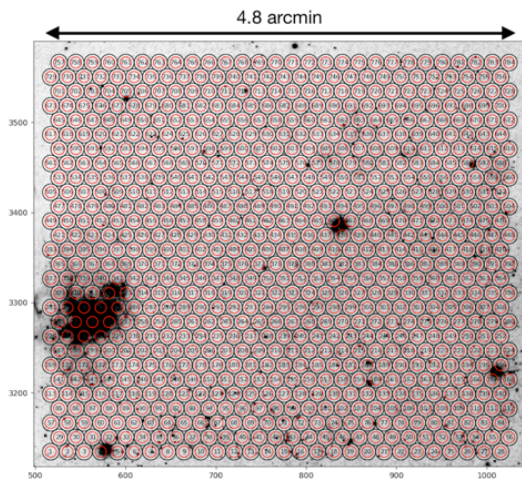
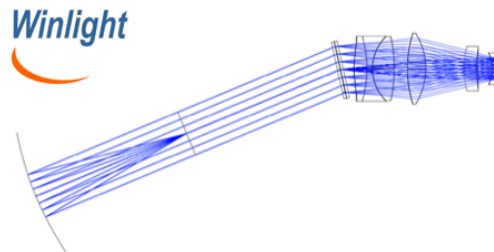

47 loci

The mechanical design of any of the preferred AAO Options will be based on that done for the Hector spectrograph being built for the AAO telescope.

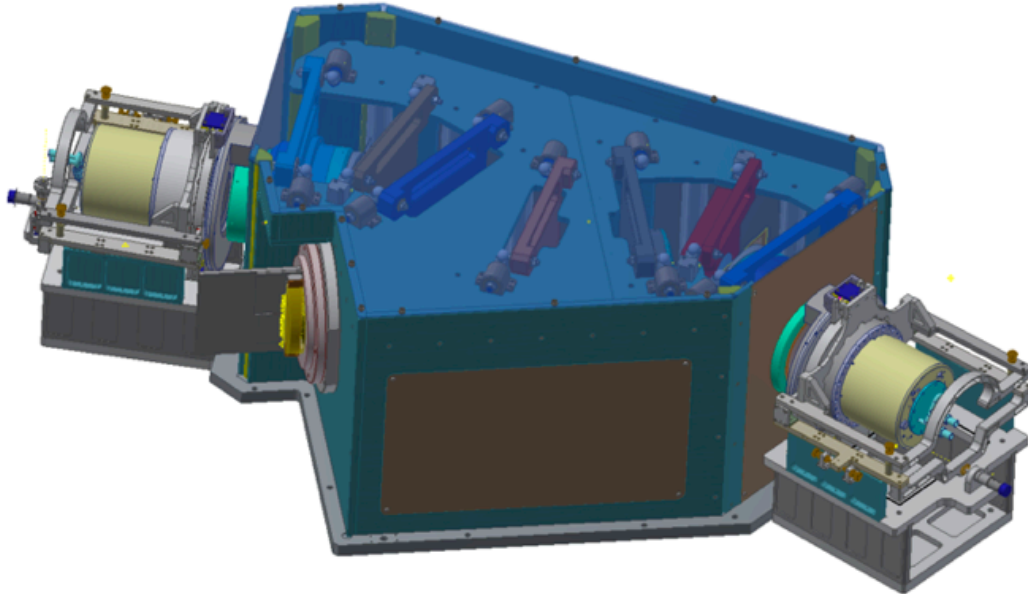

Spectrograph transmission:

The figure shows the % transmission for spectrograph Option 3; very similar to Options 1 and 2. Option 4, not shown, would have faster drop at the edges because the larger bandwidth a faster drop in grating efficiency. The figure includes all optics pertaining only to the spectrograph.

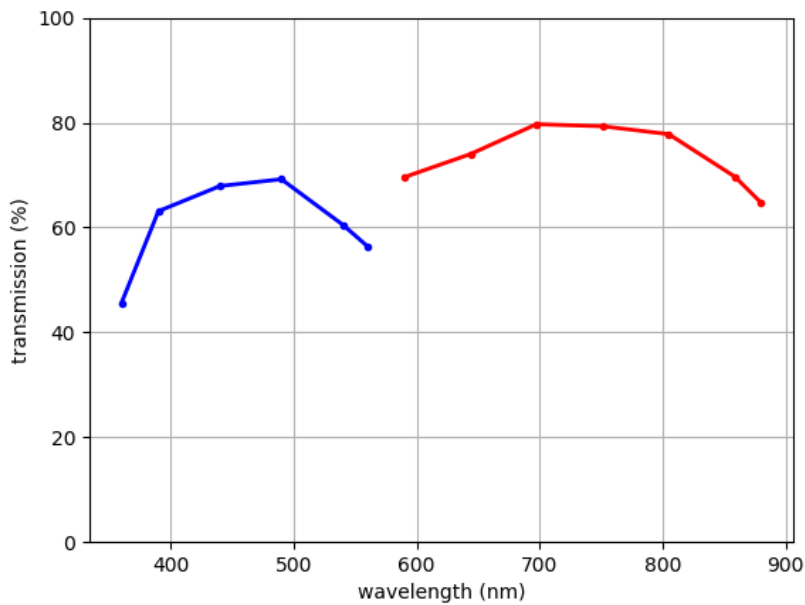

In the case of the Winlight 1-arm spectrograph the mechanical design will be based on the DESI experience. There are no critical or major risks.

C.7. Detector system

We are considering the scientific e2v CCD Sensor 4096 x 4096

Pixels:

- blue arm: CCD231-84 Back Illuminated
- red arm: CCD thick red sensitive

The blue CCD will be provided by CAHA; see below for its properties.

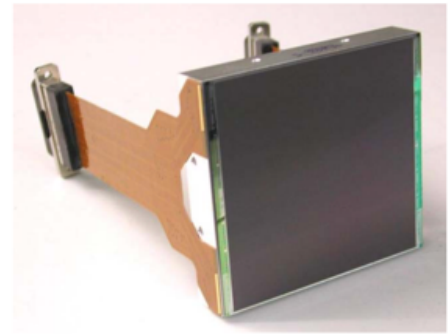

SUMMARY PERFORMANCE (Typical)

Number of pixels	4096(H) x 4112(V)
Pixel size	15 μm square
Image area	61.4 mm x 61.4 mm
Outputs	4
Package size	63.0 x 69.0 mm
Package format	silicon carbide with two flexi connectors
Focal plane height, above base	15.0 mm
Height tolerance	$\pm 10 \mu\text{m}$
Connectors	two 37-way micro-D
Flatness	<20 μm (peak to valley)
Amplifier sensitivity	7 $\mu\text{V}/\text{e}^-$
Readout noise	5 e^- at 1 MHz 2 e^- at 50 kHz
Maximum pixel data rate	3 MHz
Charge storage (pixel full well)	350,000 e^-
Dark signal	3 $\text{e}^-/\text{pixel}/\text{hour}$ (at $-100 \text{ }^\circ\text{C}$)

Pending a formal agreement, the CCD dewar will be provided by INAOE based on their previous experience with MEGARA at GTC.

The detector mount cradle design for the spectrograph with 5-axis adjustment will be based on the design for Hector at AAO, see below.

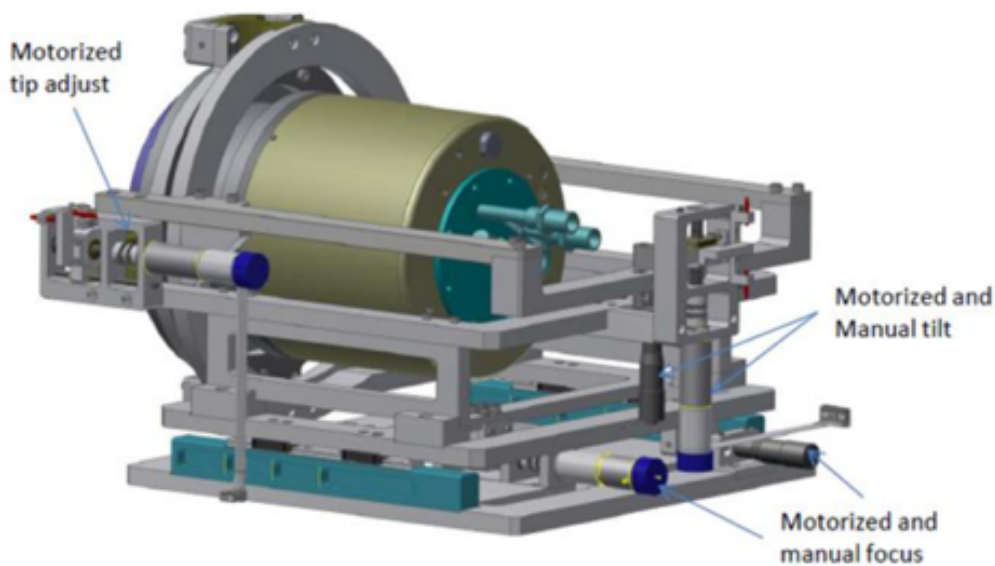

In the case of the Winlight 1-arm spectrograph we can also adopt the MEGARA solution developed by INAOE.

(D) Electronics, Software Control and Data system

D.1 Instrument Control System structure

The system in charge of the control of whole instrument (sensors, mechanisms, cameras and telescope) is the Instrument Control System (ICS). This section will give a general description of the LUCA@CAHA-Schmidt ICS, both electronics and software control.

The structure of ICS can be divided into three main subsystems:

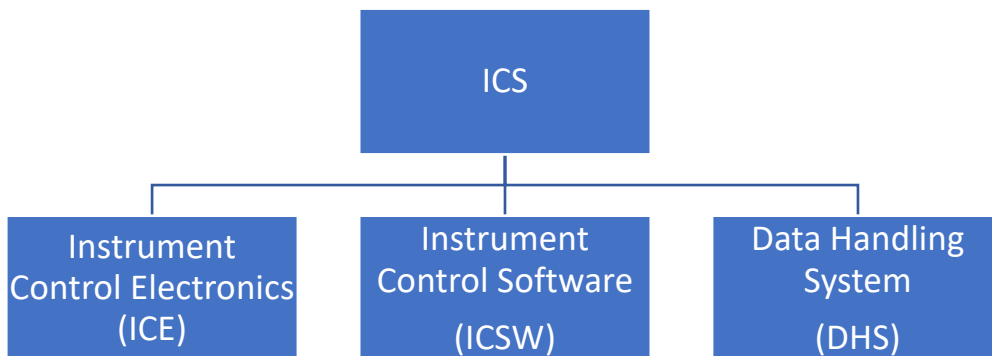

ICS Structure

The conceptual architecture of the ICS has been converted to separate work packages/sub-systems and the interaction between them will be controlled by the instrument control software. Next figure shows the ICS Product Breakdown Structure, addressing the three main sub-systems described before: electronics, software and data processing and storage.

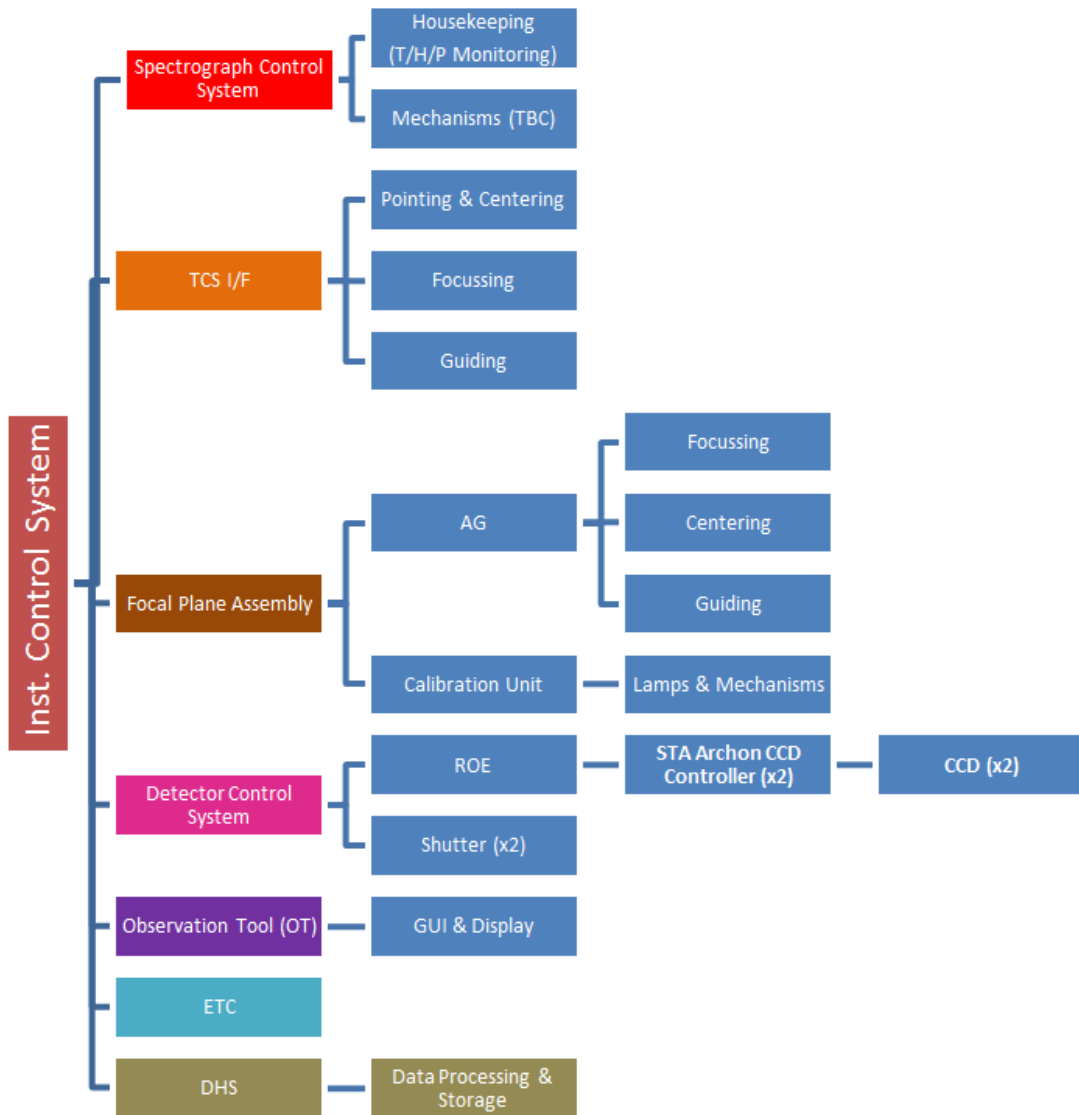

ICS Product Breakdown Structure (PBS)

D. 2. Instrument Control Electronics (ICE)

The LUCA@CAHA-Schmidt instrument control electronics (ICE) package consists of several hardware components to control the devices required for the instrument operation. The choice of the hardware components will be driven by well-established industrial standards and Commercial Off-the-Shelf (COTS) products and CAHA recommendations.

- Mechanisms control:

The instrument will not have many complex mechanisms to control, but only for the calibration unit and the detector shutter.

- Shutter (Uniblitz): controlled by CCD-ROE (Archon ST) trigger out signal.
- Calibration Unit:
 - Calibr. Mechanisms: Embedded PC Beckhoff CX-51xx
 - Cal. Lamps: HCL Power Supply (P209) + Embedded PC-PLC (CX-51xx)

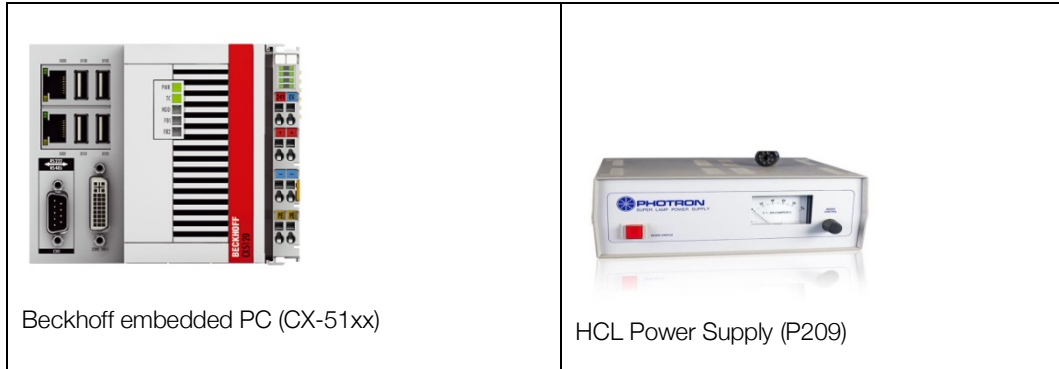

- Housekeeping & Monitoring: the temperature, humidity and pressure sensors for the instrument monitoring will be handled by the same Beckhoff embedded PC used for the Calibration Unit.
- CCDs Readout Electronics (ROE)

The Archon modular CCD controller is purposed as the CCD detector side controller. It is a high performance modular CCD controller developed by Semiconductor Technology Associates, Inc (STA). It receives configuration information from and sends status and image data to a host PC via a gigabit Ethernet connection (either copper or fiber). Power is supplied to Archon through a circular connector carrying the DC voltages necessary for a particular system or through a standard AC power cord for Archon AC. The CCD to be operated is connected to Archon through a custom interface board, built to route signals from the CCD cabling to the internal Archon module connectors.

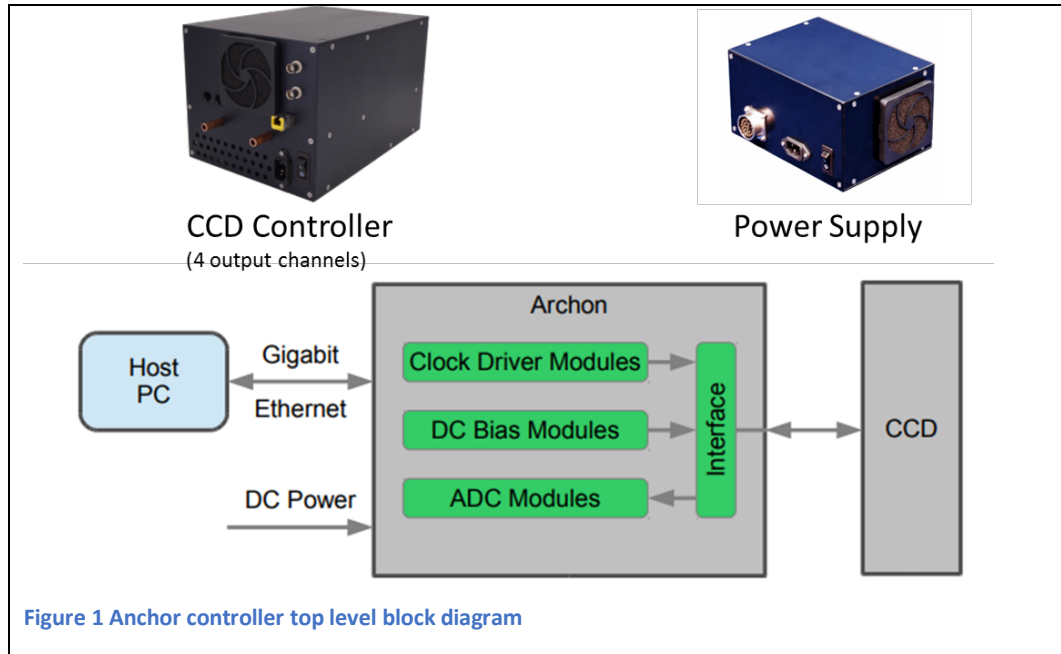

The Archon controller consists of a FPGA with an instantiated 32-bit CPU, supporting memory and Ethernet controller. This highly modular system incorporates 16-bit for-channel ADC modules, four such modules will be utilized – one per detector. To minimize noise insertion, the Archon system will be located immediately on top of the CCD’s giving the minimal possible cabling from the raw analog CCD raw output to the input preamps on the ADC modules.

Notice that the Archon controller is used by both the Zwicky Transient Facility (ZTF) and the Large Synoptic Survey telescope (LSST).

- A&G Cameras:

The cameras purposed for the A&G systems are the Atik 414EX CCD, USB interface controlled and fed by Coherent fiber bundles at the LUCA Schmidt Focal Plane (see pictures below).



Atik 414EX CCD

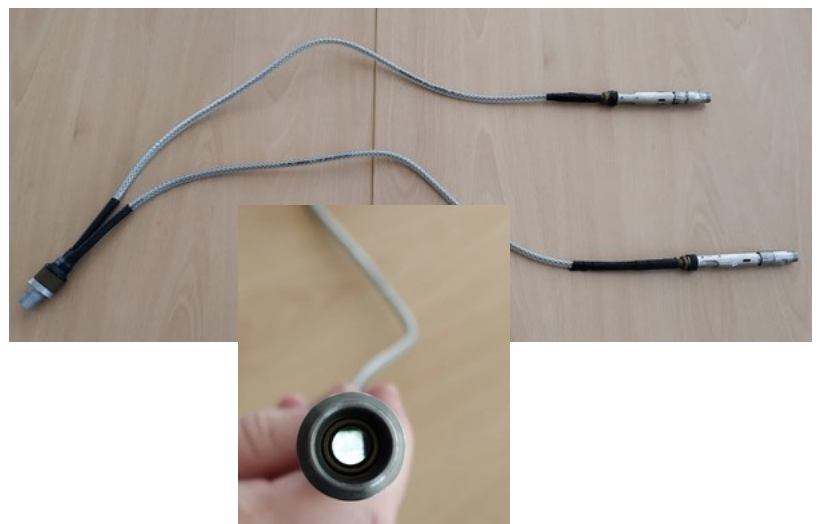

Next figure shows the hardware interfaces involved in the control of the hardware devices purposed for the ICE.

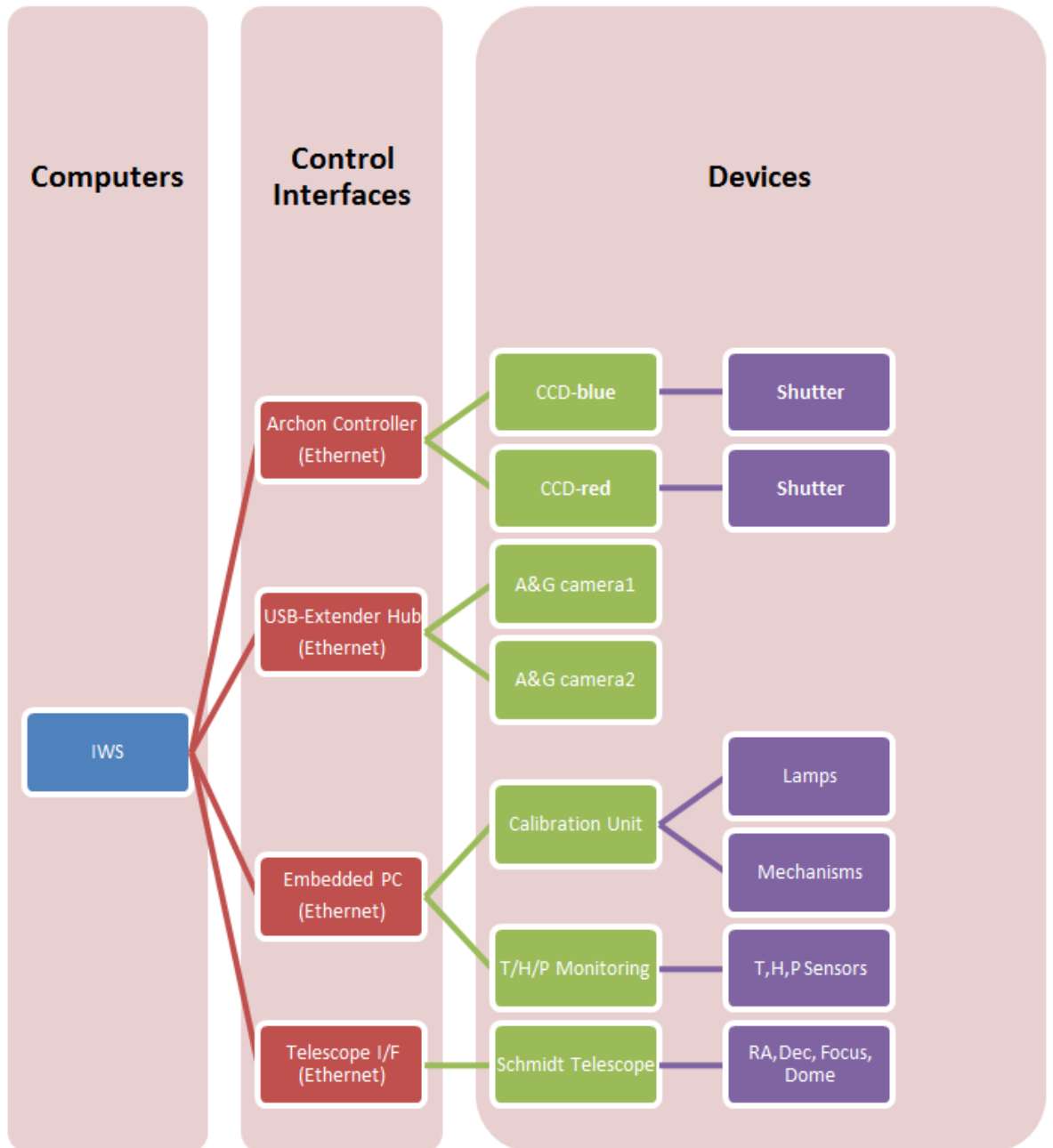



D. 3. Instrument Control Software (ICSW)

This section describes the proposed components of LUCA@CAHA-Schmidt instrument control software (ICSW). Science data reduction software is out of the scope of this section, and will be addressed in a different document.

The ICSW is comprised of the next components:

- Telescope Interface (TCS)
 - CAHA standard: based on INDI (TBC)
 - Functions: Pointing, Focusing and Guiding
- Spectrographs Control Software (SCS)
 - Housekeeping & Monitoring
 - Calibration Unit control
 - Room Thermal Control (TBC)
- CCD Control Software (CCS)
 - Based on Archon GUI source code (provided by STA)
- AG Control Software (ACS)
 - Open PHD2 Guiding + INDI (telescope + camera driver)
- Observation Tool (OT)
 - GUI for Observations preparation and run, and image display.

Software development Environment

The software will be developed in the C/C++ and Python programming languages. Qt libraries for GUI and TwinCAT3 environment for embedded PC, will also be used.

The instrument control workstation (IWS) will be based on CentOS operating System and the Beckhoff embedded PC will run WindowsCE OS.

The Git revision control software will be used for software configuration management.

Data Handling System:

The LUCA@CAHA-Schmidt data handling system will be in charge of the data processing and storage of the data produced by the instrument. It will be composed by two main computers: the Instrument Control Workstation (IWS) and the Data Processing Workstation (DPW). Additionally, the data obtained will be copied daily to the CAHA Archive system.

- Instrument Control Workstation (IWS)
 - Run Observation Tool and Display Tool
 - 1 month storage, with fast storage disks (SSD RAID1)
- Data processing Workstation (DPW)
 - Run Pipeline and Quick Look tools (QL)
 - Massive Storage Disks for LUCA Survey (RAID5)

- Run Web server for web front-end
- CAHA Archive
 - LUCA data are copied daily to CAHA archive

Therefore, the DHS will provide the infrastructure and procedures needed to store the raw data (FITS files) generated by the instrument and the data produced by the data reduction pipeline and Quick Look (QL) tool. In principle, night data will be stored in the IWS with a storage capacity for at least one month. Then, data will be copied daily to the LUCA Data Processing Workstation (DPW) for its processing and to the CAHA Archive.

Additionally, and for the LUCA data release, a web interface will be provided to liberate the data fully reduced and quality controlled.

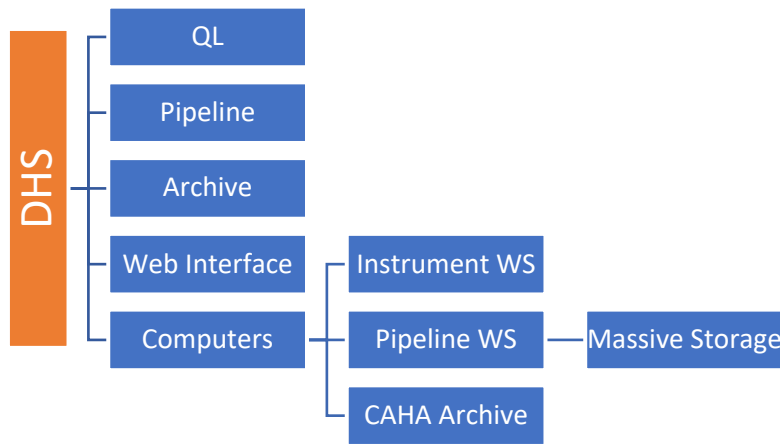

LUCA@CAHA-Schmidt Data Handling System

Due to long exposition times, the instrument will not generate a large volume of data, approximately 4x4kx4k (16bits) frame per astronomical night hour, approximately 128 MB per hour, what means approximately 1280 MB/night (10hours/night).

For the case of the new Winlight 1-arm spectrograph there will be an additional mechanism to control, i.e., the Hartman doors. Winlight can provide the control electronics (see Appendix B).

The details of the steps for data processing will not be addressed in this section.



Acquisition & Guiding. Assessment of Gaia Guiding Stars

We use the Gaia database through the astroquery interface to generate sky fields with stars. For the Schmidt scale at the focal plane of 86.20 arcsec/mm and a typical guiding detector of size 4x4mm (e.g. a CMOS 1000x1000 pixels of 4micron each) the FoV to search for guiding stars at any one location on sky is 5.75'x5.75'.

To study the availability of stars for guiding, we generate random locations on a sphere and select 10000 fields with declination above -22.78° (so that maximum airmass < 2). We then count the stars brighter than a given magnitude (Gaia 'phot_g_mean_mag'). The figure shows the percent number of these fields with at least one guide star brighter than a given magnitude. Clearly, basically almost any 5.75'x5.75' location on the sky has guide stars brighter than 16 mag, which guarantees that we can guide by having a single CMOS located at the Focal Plane next to the IFU.

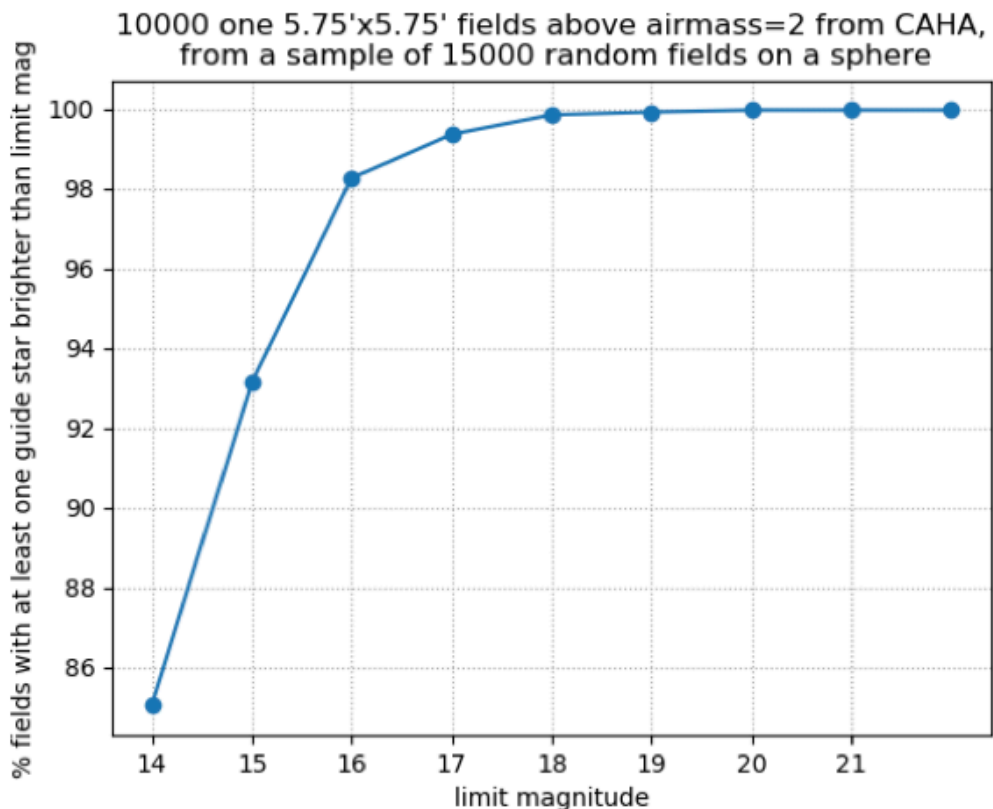

Exposure times

We use the uncalibrated M33 JPLUS i-band image (kindly provided by Dra. San Román) together with the surface brightness profile of Ferguson et al (2006) to obtain a calibrated i-band image of M33. Over this image we project the fiber bundles for two spectrograph options (AAO Option4 and Winlight), do the fiber photometry, add noise to a $S/N=10$, project and spread on to the CCD to produce an raw stacked spectrum (rss) observation-like image for each IFU pointing. We then fit gaussians along the slit and extract the photometric profiles. The comparison injected versus recovered photometry is shown in the figure below (for AAO Option4).

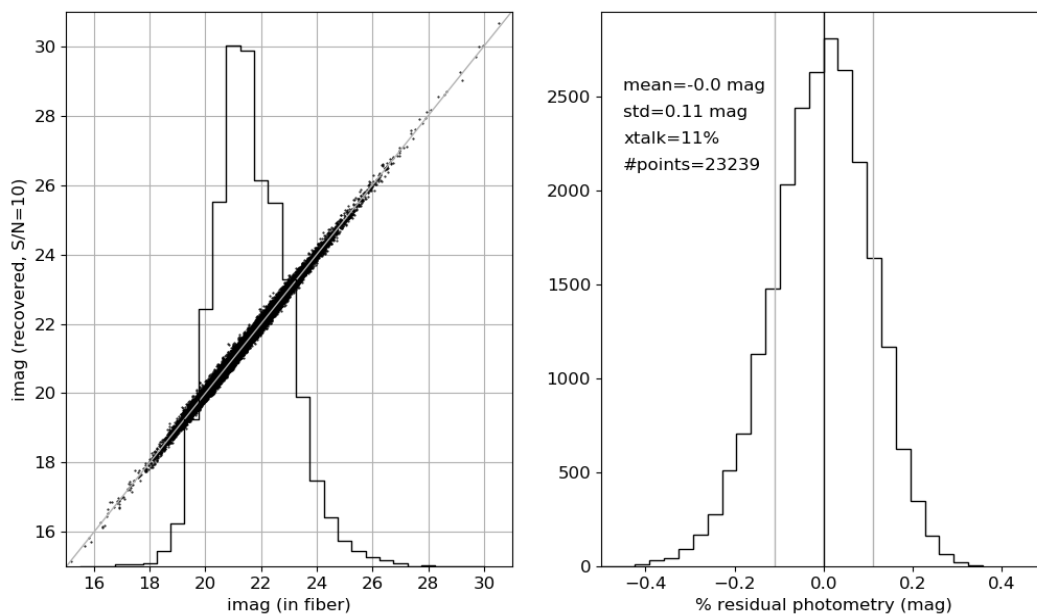

We use the 4MOST exposure time calculator scaled to the telescope size and fiber core size to transform the fiber photometry to an equivalent exposure time for a mean $S/N=10$ per IFU pointing.

The figure below shows the resulting map of exposure times (in hours).

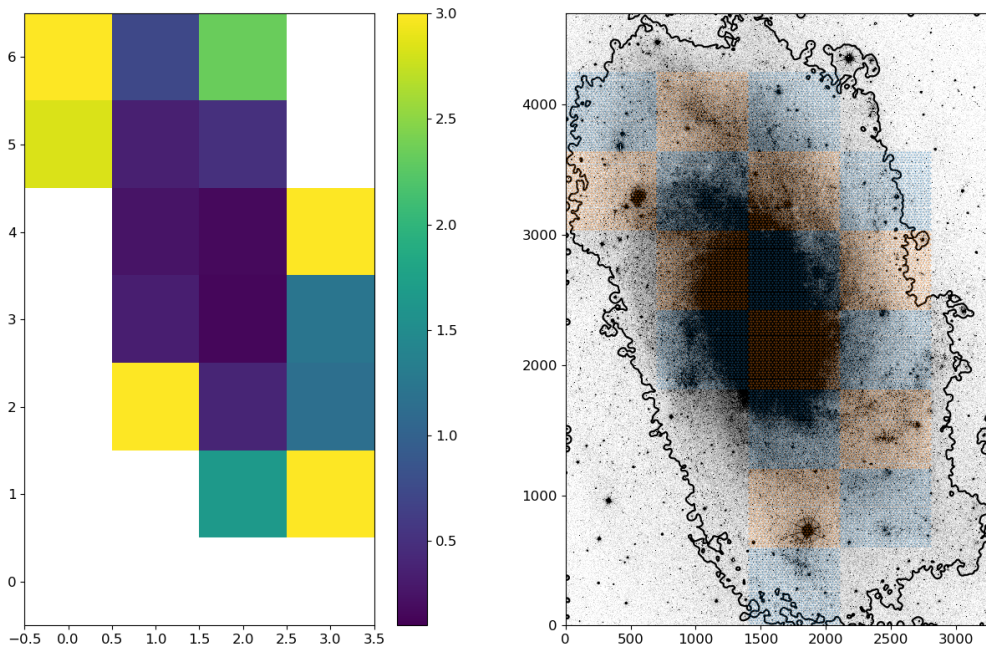

(Left) Exposure time (hours) map per IFU pointing for the AAO Option4 spectrograph. Pointings that require less than 3 hours are shown. The IFU pointings in the outskirts would require disproportionately larger exposures. (Right) Reference M33 image and all IFU pointings.

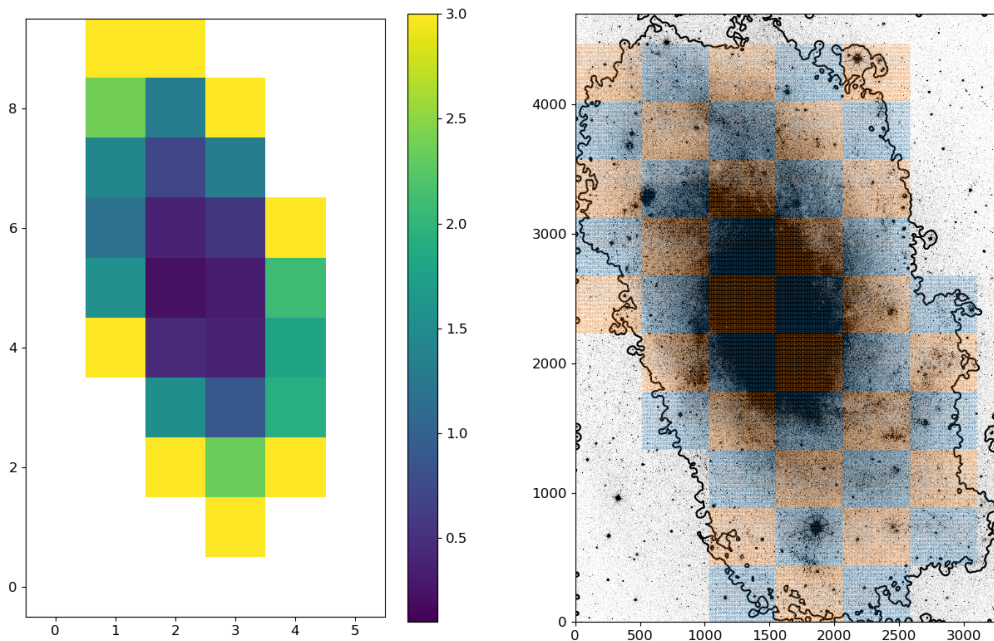

As above for the Winlight spectrograph option.

Taking into account all three major targets (M31, M33, and M101) and the need to go to a sufficiently deep isophote, a total survey time of about 3 effective years would be required. A more precise calculation will be made in the next phase of the project.



5. Project Layout: work packages

We provide the list of work packages together with the institutions responsible for their delivery. This is pending of a proposal and a formal agreement.

- Schmidt Telescope [CAHA]
 - Telescope Control System
 - Focusing, Pointing, Seeing characterisation
 - Spectrograph Room
 - Control Room
- Focal Plane Assembly [IAA, Durham]
 - Integral Field Unit - A&G Unit - Instrument Structure Assembly
- Fiber System [Durham + Manufacturing Companies]
 - 20 m Fiber Cable - Connector - Spectrograph Slit Assembly
- Spectrograph [AAO or Winlight]
 - Opto-Mechanical Components - Optical Bench - Optical Alignment
- Detector System [Simon Tulloch + INAOE, Companies]
 - Cryostats - CCDs - Readout Electronics
- Assembly Integration Verification [IAA]
- Data System [IAA]
 - Control Software - Data Acquisition Software - Data Reduction Pipeline
- Survey Operations [IAA]
 - Exposure Time Calculators - Tiling Strategies - Target Selection - Observing Strategies
- Data Releases Plan [IAA]

6. Project schedule and cost

It is a must for the IAA that the LUCA spectrograph at the Calar Alto Schmidt telescope will see first light and will deliver its first set of science data before the end of the Severo Ochoa Award. This requirement drives the schedule of LUCA@CAHA Schmidt. Thus, first light at the telescope is foreseen for June 2021.

See below the Gantt Chart for the tentative Project Schedule of LUCA@CAHA Schmidt.

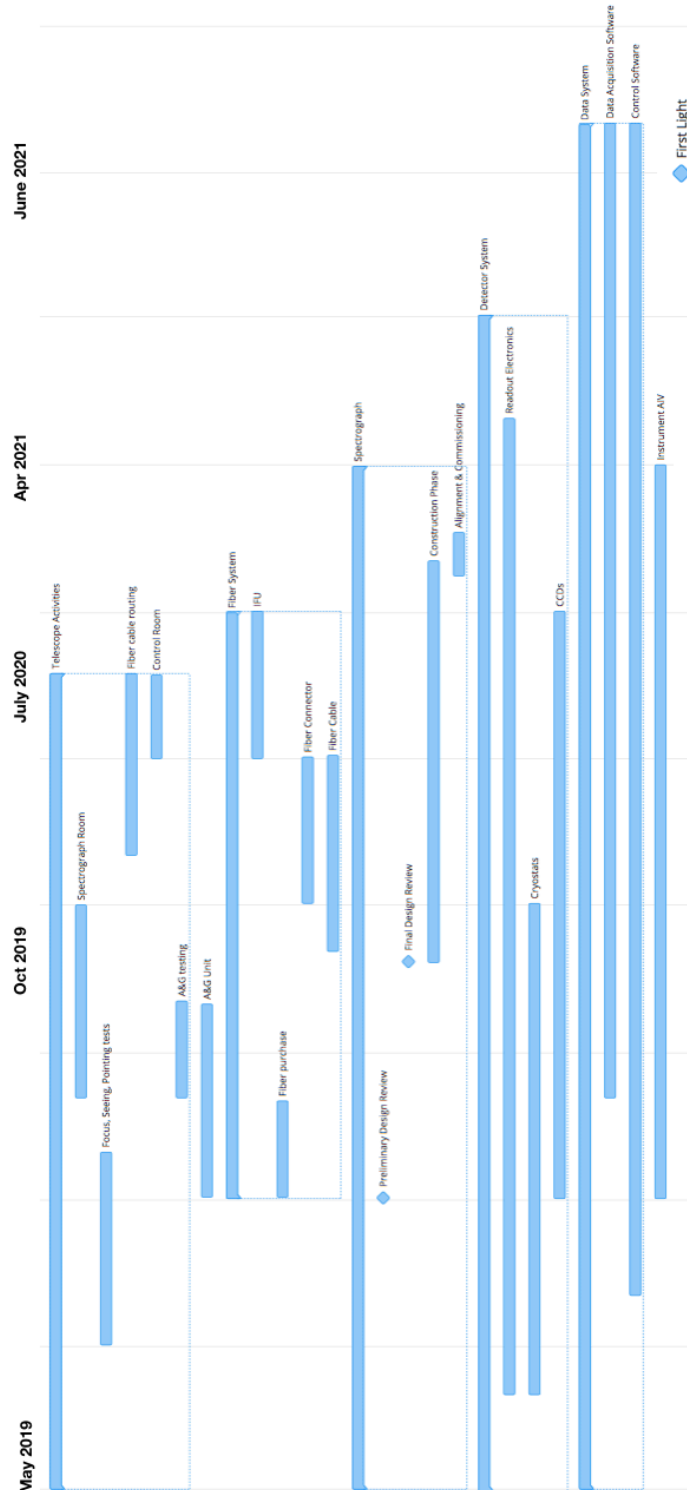



Table below shows the schedule estimate for the spectrograph construction of LUCA@CAHA Schmidt provided by the AAO (see Appendix A for more details):

Milestone	Due date
Finalise optical design	T_0
Order all optics (lenses/ gratings/ dichroic)	$T_0 + 1-3$ months
Complete mechanical design and release all drawings for manufacture	$T_0 + 10-12$ months
Procurement complete (all optics received and tested, all mechanical parts fabricated)	$T_0 + 15-18$ months
Assembly and test complete (ready for shipping)	$T_0 + 18-24$ months

We also provide the schedule, see below, provided by Winlight for the construction of their 1-arm spectrograph design (see Appendix B for more details).

Phase	Delivery time
Study	$T_0 + 8$ months
Glass blank procurement (will start at $T_0 + 3$ months)	$T_1 + 6$ months = $T_0 + 9$ months
Optical manufacturing (including coating)	$T_1 + 12$ months = $T_0 + 15$ months
Integration, alignment and testing of the spectrograph	$T_1 + 16$ months = $T_0 + 19$ months
Delivery	15 days after acceptance

Note that in the Gantt chart above, to finalize the optical design, we have scheduled the Final Design Review of the Project by October 2019.

Project Budget estimate of LUCA@CAHA Schmidt:

We have already been granted funding for the construction of the LUCA spectrograph and the fiber system at the CAHA Schmidt telescope thanks to two grant awards,

- (1) 120000 euro by the Spanish Ministry of Science and Innovation through its 2018 Scientific Infrastructure Call (Ref. EQC2018-004621-P),
- (2) 450000 euro by the regional Junta de Andalucía program to strengthen research institutes for the acquisition of the "Severo Ochoa" award of excellence (Ref. SOMM17/5208/IAA).

The blue sensitive e2v CCD will be provided by CAHA (120k euro).



The CCD Cryostats will be delivered by INAOE (200k euro for 2 units, pending of agreement). Our current budget is 570k euro (IAA) + 200k euro (INAOE, TBC) + 120k euro (CAHA).

We provide below two budget estimates depending on each of the selected spectrograph scenarios, i.e., AAO vs. Winlight:

A) Project budget in the “AAO” scenario:

Instrument Systems	2019	2020	2021
A&G, Focal Plate Unit	5k	20k	
IFU + 20m Fiber Cable	120k		
Fiber Connector		25k	
Slit Assembly		35k	
Spectrograph (Option 4)	50k	400k + 100k	350k
1 Cryostat		100k	
1 CCD e2v		120k	
1 CCD Controller	35k		
Control & Software	0.5 FTE	1 FTE	0.5 FTE
PM & System Engineer	0.5 FTE	1 FTE	0.5 FTE
Detector Sys. Consultant Consultancy	12k	24k	12k
Fiber Sys. Consultant ConsConsultancy	18k	35k	18k
TOTAL BUDGET	170k + 70k + 1FTE	520k + 100k + 239k + 2FTE	380k + 1FTE

Amounts in white correspond to approved IAA funding and CAHA CCD, in green INAOE contribution (pending of agreement), and in red the requested funding needed to complete the entire instrument construction. Note that the yearly cost of the spectrograph construction will have to be discussed with AAO. See Appendix A for more details regarding the AAO proposal.



B) Project budget in the “Winlight” scenario:

Instrument Systems	2019	2020	2021
A&G, Focal Plate Unit	5k	20k	
IFU + 20m Fiber Cable	120k		
Fiber Connector		25k	
Slit Assembly		35k	
Spectrograph (Winlight)	170k	175k	109k
1 Cryostat		100k	
1 CCD e2v		120k	
1 CCD Controller	35k		
Control & Software	0.5 FTE	1 FTE	0.5 FTE
PM & System Engineer	0.5 FTE	1 FTE	0.5 FTE
Detector Sys. Consultant Consultancy	12k	24k	12k
Fiber Sys. Consultant ConsConsultancy	18k	35k	18k
TOTAL BUDGET	290k + 70k + 1FTE	295k + 100k + 139k + 2FTE	109k + 30k + 1FTE

Amounts in white correspond to approved IAA funding and CAHA CCD, in green INAOE contribution (pending of agreement), and in red the requested funding needed to complete the entire instrument construction. See Appendix B for more details regarding the Winlight proposal.

7. Competition beyond 2020: SDSS-V Local Volume Mapper

The SDSS-V Local Volume Mapper is planned to start observations beyond 2020. All details can be found in arXiv:1711.03234. In the Chart below one can see a summary of the project, which intends to perform IFU mapping of

- Milky Way , LMC
- M31, M33 and other galaxies out to 5 Mpc:
 - sparse IFS sampling
 - statistical samples of HII regions at 20 pc resolution in M31 and ~50pc in other galaxies

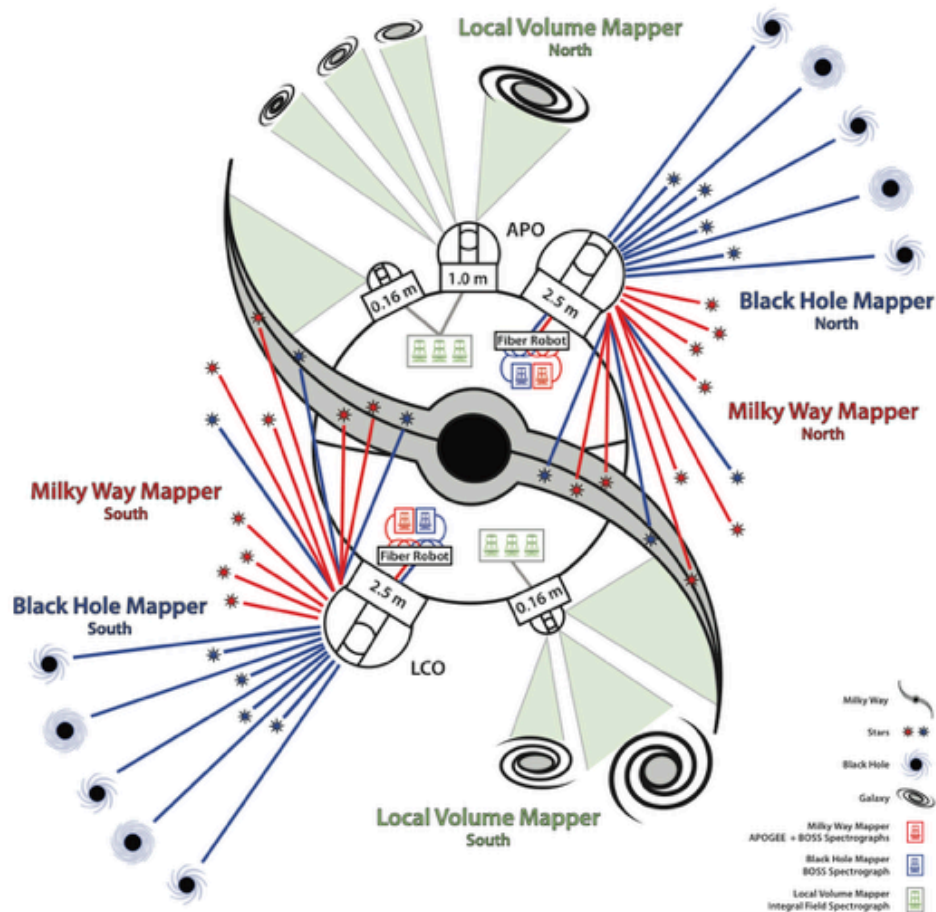

The SDSS-V LVM footprint and sampling strategy is shown below.

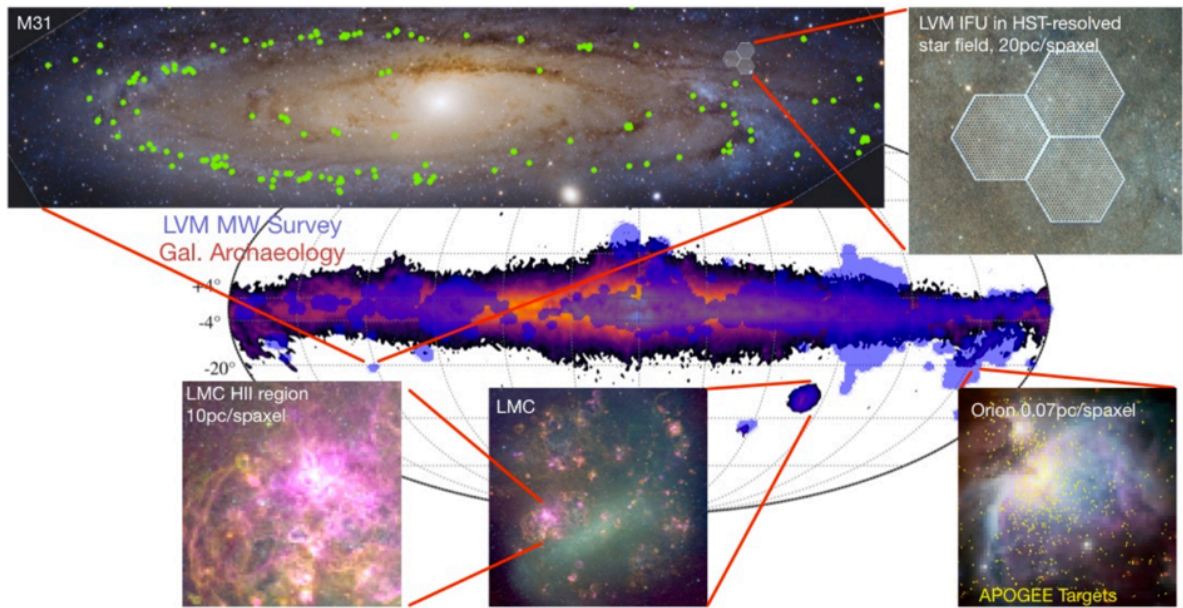

SDSS-V LVM is complementary to LUCA since does not intent to perform an entire IFU mapping of M31, M33 and M101. In this regard LUCA will be unique and will offer to the IAA and the astronomical community with an invaluable legacy, which will be fundamental in our understanding of galaxy formation and evolution, and will result key for follow-up studies in the ELT era.



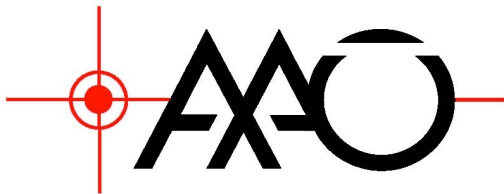

APPENDIX A



CALAR ALTO SCHMIDT TELESCOPE SPECTROGRAPH OPTIONS

***CALAR ALTO SCHMIDT TELESCOPE
SPECTROGRAPH OPTIONS***

Rev No.	Document Authors/Contributors	Approval	Date
1	J. Lawrence, R. Content, M. Mahesh, H. McGregor		12 Apr 2019
		J. Lawrence	
2	J. Lawrence, R. Content, M. Mahesh, H. McGregor		23 Apr 2019
		J. Lawrence	
3	J. Lawrence, R. Content, M. Mahesh, H. McGregor		29 Apr 2019
		J. Lawrence	

1 INTRODUCTION

This document presents a trade-off between 4 options for the Calar Alto Schmidt telescope. For each, we give specifications, optical layout, optical performance, mechanical design principals, and expected costs. The spectrographs are based around the designs for the AAO's TAIPAN and Hector spectrographs. Specification and performance is also given relative to the DESI spectrograph, a clone of which has been considered for this project.

2 DESIGN OPTIONS

Four options are considered:

1. Schmidt_Paco_Hector (SPH). This design was developed based on the motivation to replicate as far as practical the Hector spectrograph design with minor variations.
2. Schmidt_Paco_Hector blue arm only (SPH_blue). This option includes the blue arm only for option 1. This design is upgradable in the future to include the red arm.
3. Schmidt_Paco_Hector lite (SPH_lite). This design was based on scaling down the size of the SPH spectrograph so that it matches the efficiency of the DESI spectrograph. Note for this option it is likely that further savings could be made by e.g., removing lenses or aspheres or changing glass type or continuing the optimisation.
4. Schmidt_LUCA (SL). This design is based around the specifications for the LUCA project. It has a single arm only with reduced wavelength coverage and resolution.

Table 1. Parameters for each option relative to the DESI clone option

Parameter	DESI	Option 1 - SPH	Option 2 – SPH blue	Option 3 – SPH lite	Option 4 – SL
Wavelength coverage (nm)	360-593 + 566-772	360-580 + 560-880	360-560 (580)	360-580 + 560-880	360-685
Spectrograph arms	2	2	1	2	1
Resolution arm 1	2140-3420	2670-4230	2670-4230	2750-4350	1750-3330
Resolution arm 2	3420-4390	2950-4640	NA	3010-4730	NA
Input element on-sky aperture (100 μ m fibre)	6.84"	7.91"	7.91"	6.84"	8.4"
Output f/ratio fore-optics	f/3.85	f/3.33	f/3.33	f/3.85	f/3.13
Input f/ratio collimator	f/3.57	f/3.26	f/3.26	f/3.77	f/3.07
Fibre core diam (pixels)	3.17	2.85	2.91	2.84	2.80
As-designed PSF (RMS micron)	10	9.7	9.7 (12.7)	8.7	12.5
Max number of fibres	890	990	990	800	910
Overall figure of merit	1.07	2.10	1.00	1.30	1.08

Table 1 provides a comparison of the parameters for each option, along with an evaluation of each with an overall figure of merit. The overall figure of merit is the product of the spectral and spatial figure of merit. It is set relative to the DESI option using their original resolution with a fibre core size of 107 micron giving 1.07. The other options use a 100 micron core fibre.

The spectral figure of merit takes into account the bandwidth and the resolution. This is done by calculating the total number of spectral elements of resolution in the total bandwidth, taking into account the dichroic overlap region. This calculation is optimistic for the DESI option as it assumes there would be no degradation if the maximum wavelength is pushed from 772nm to 880nm and the resolution reduced to maintain the same number of spectral elements.

For the spatial figure of merit, the surface area of each fibre and the total number of fibres both count. The total surface area of the field is thus obtained by adding the field of all the fibres.

Note that when taking into account the overall figure of merit there is still some room to drive the costs down for options 3 and 4.

3 OPTICAL DESIGN

3.1 Option 1 – SPH

The optical design for SPH is shown in Figure 1. The design is based around the optical design for the Hector spectrograph for the Anglo-Australian Telescope. It shares a number of elements in common, though has been modified to accommodate a wider wavelength range. It provides a substantial gain in throughput (due to smaller focal ratio input) and efficiency (resulting from the wider slit length) relative to the DESI design. Representative spot diagrams are shown Figure 2 and Figure 3.

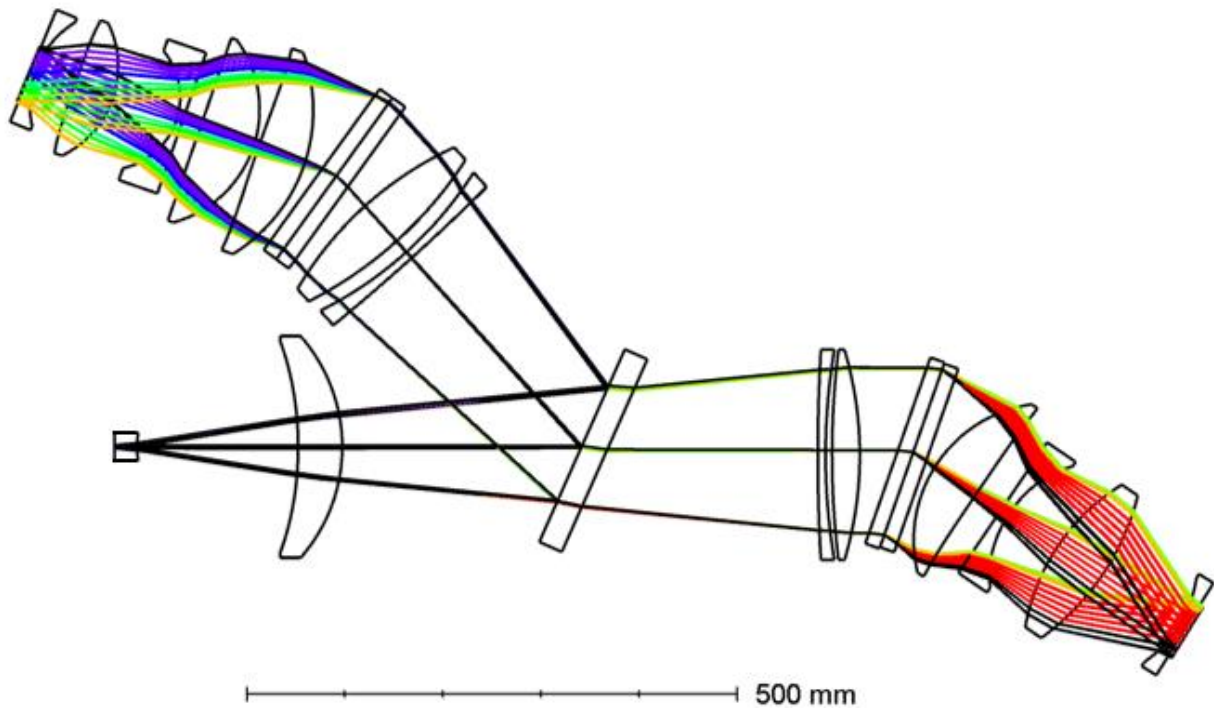

Figure 1. Optical layout for SPH

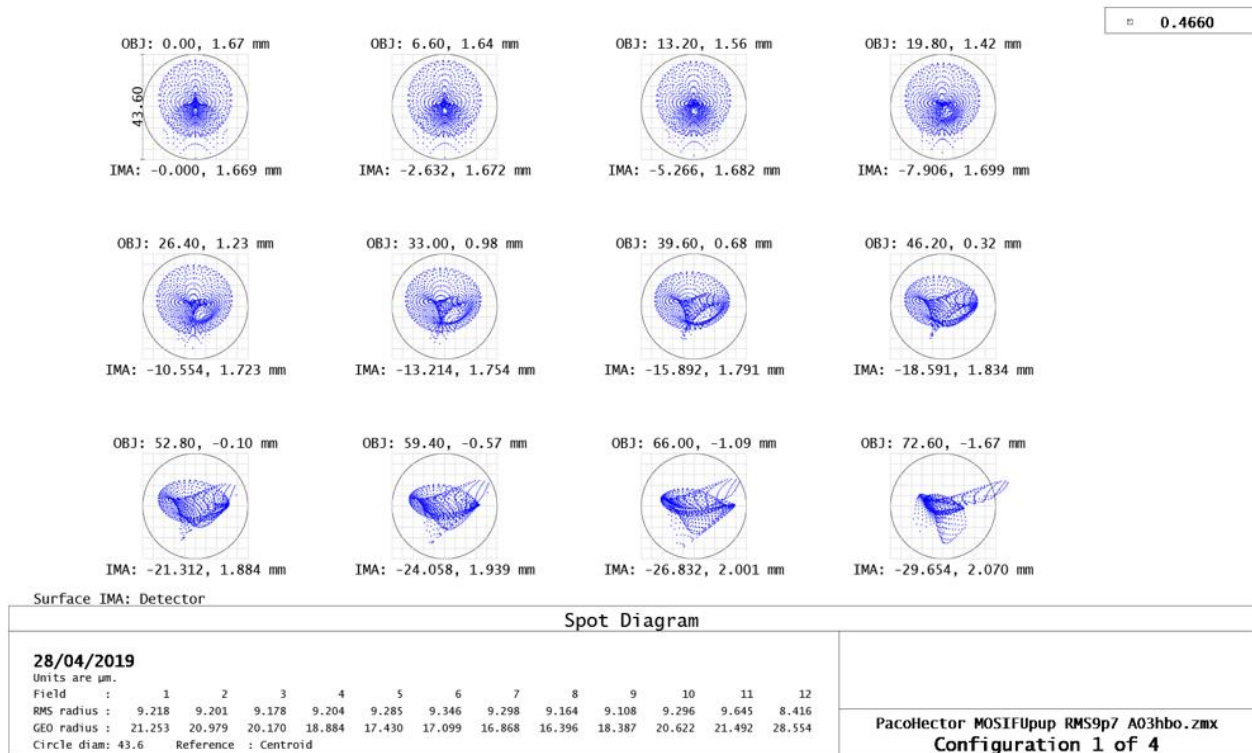

Figure 2. Full field spot diagram for SPH in the middle of the blue arm 466 nm. Circle is fibre core footprint.

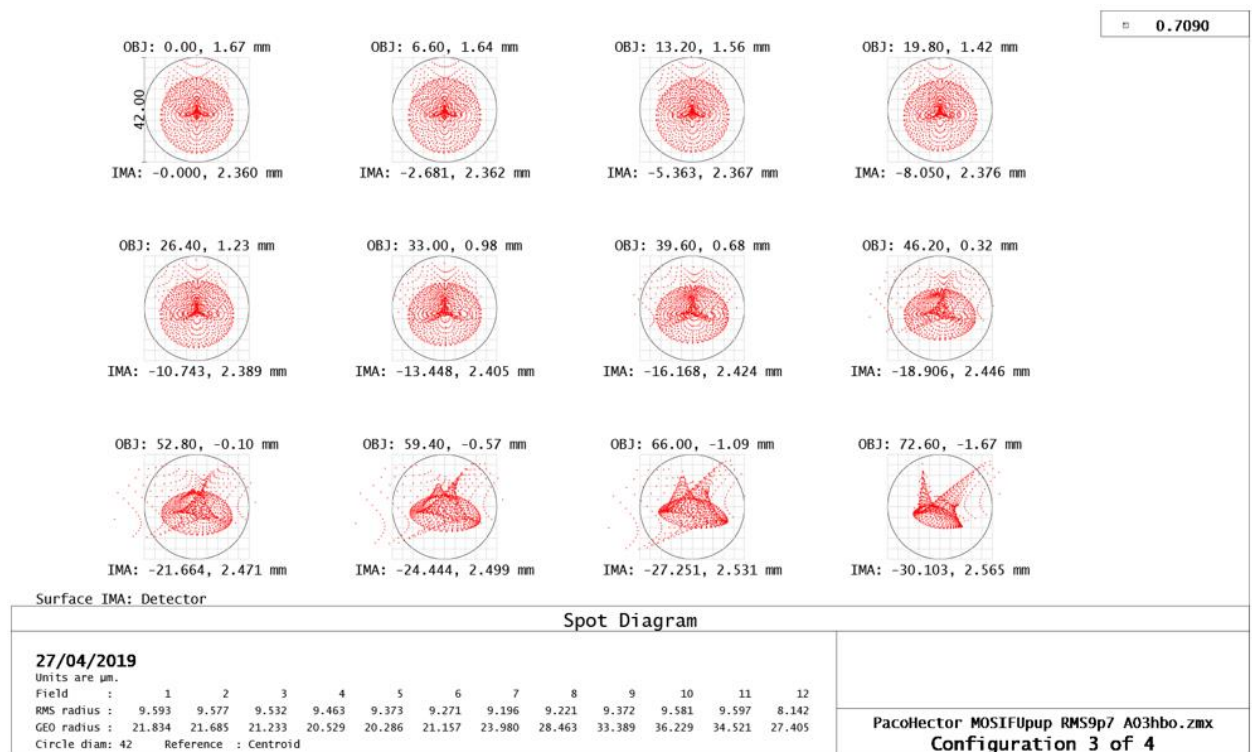

Figure 3. Full field spot diagram for SPH in the middle of the red arm at 709 nm. Circle is fibre core footprint.

3.2 Option 2 – SPH_blue

SPH_blue option is the blue channel only for SPH (Figure 4). For installation a mirror is used in place of the dichroic to allow for a future upgrade where space and appropriate interfaces would be left for later upgrade of the instrument to include the red arm. Alternatively, the blue arm could be placed to the right without the mirror.

The optical performance for SPH_blue follows that for SPH (Figure 2).

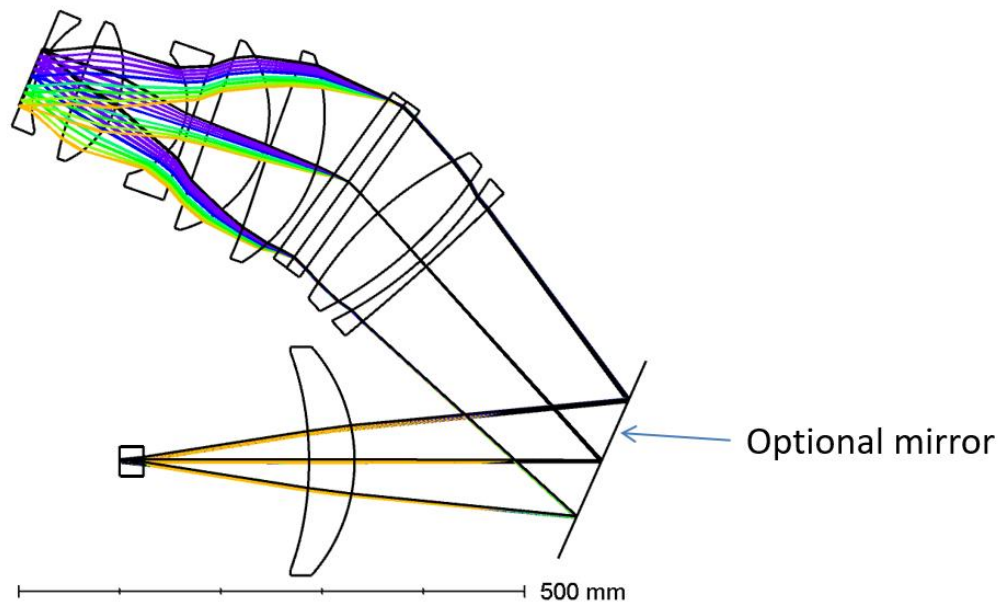

Figure 4. Optical layout for SPH-blue

3.3 Option 3 – SPH_lite

The SPH_lite option reduces all optics diameters by reducing the slit length and focal ratio. The optical layout is shown in Figure 5. Representative spot diagrams are given in Figure 6 and Figure 7.

The slit length of DESI is 120.9 mm compared to the 145.2 mm of Paco Hector. DESI has however a slit curvature in the “wrong” direction which reduces the effective length by about 5% according to our work on another version of Hector. The length of slit used in Option 3 SPH_lite has then been chosen as 115 mm.

The focal ratio of DESI is 3.57 compared to the focal ratio of Paco Hector of 3.26. DESI was however designed for a 3.85 focal ratio with its pupil blurred by focal ratio degradation (FRD), a very different design than for a 3.57 focal ratio. We have simulated an F/3.85 pupil blurred by a 1° FRD, something worse than expected performance of the fibre cable. It shows that there is only a few tenths of 1% of the light outside F/3.77. It would be a waste of money, at least a few percent of the total cost, if F/3.57 was used instead, possibly many percent. F/3.77 was then chosen with the proper filter simulating the FRD on an F/3.85 beam.

The spectral resolution of Paco Hector was maintained and is in fact a bit better, a resolution better than that of DESI for the same total spectral length of 360-880nm.

The present design shows a very significant improvement of the cost relative to SPH. This is however not still optimized because the performances are “too good” so there is still some space to reduce the cost again in the next iteration of the design.

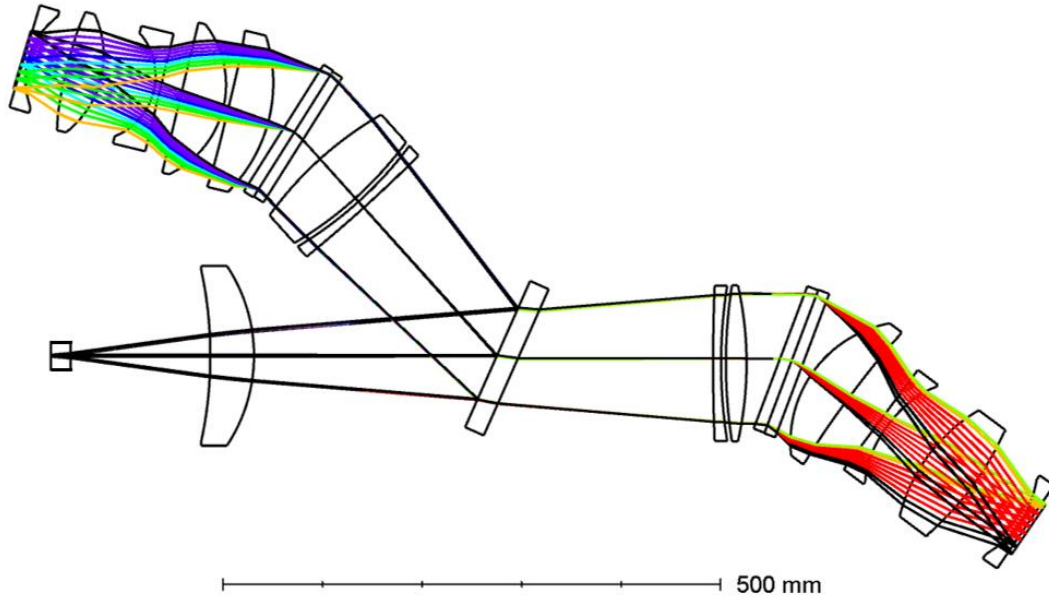

Figure 5. Optical layout for SPH-lite

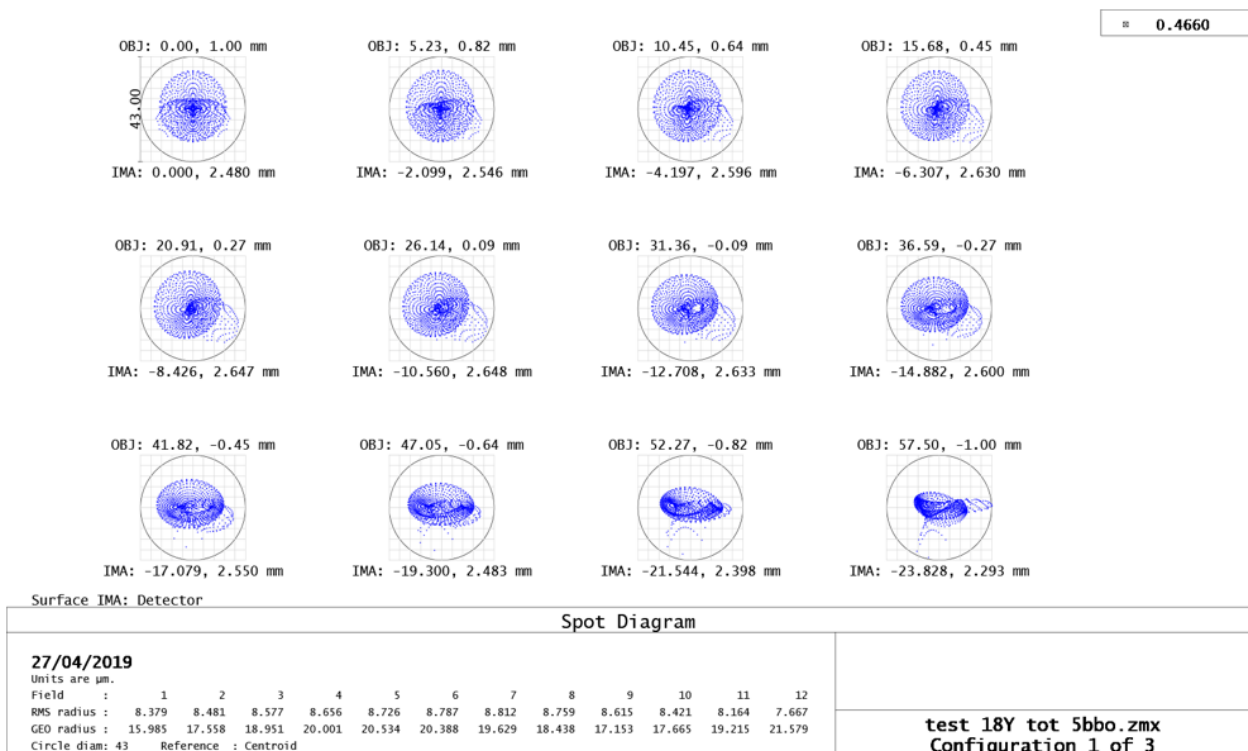

Figure 6. Full field spot diagram for SPH_lite in the middle of the blue arm at 466 nm. Circle is fibre core footprint.

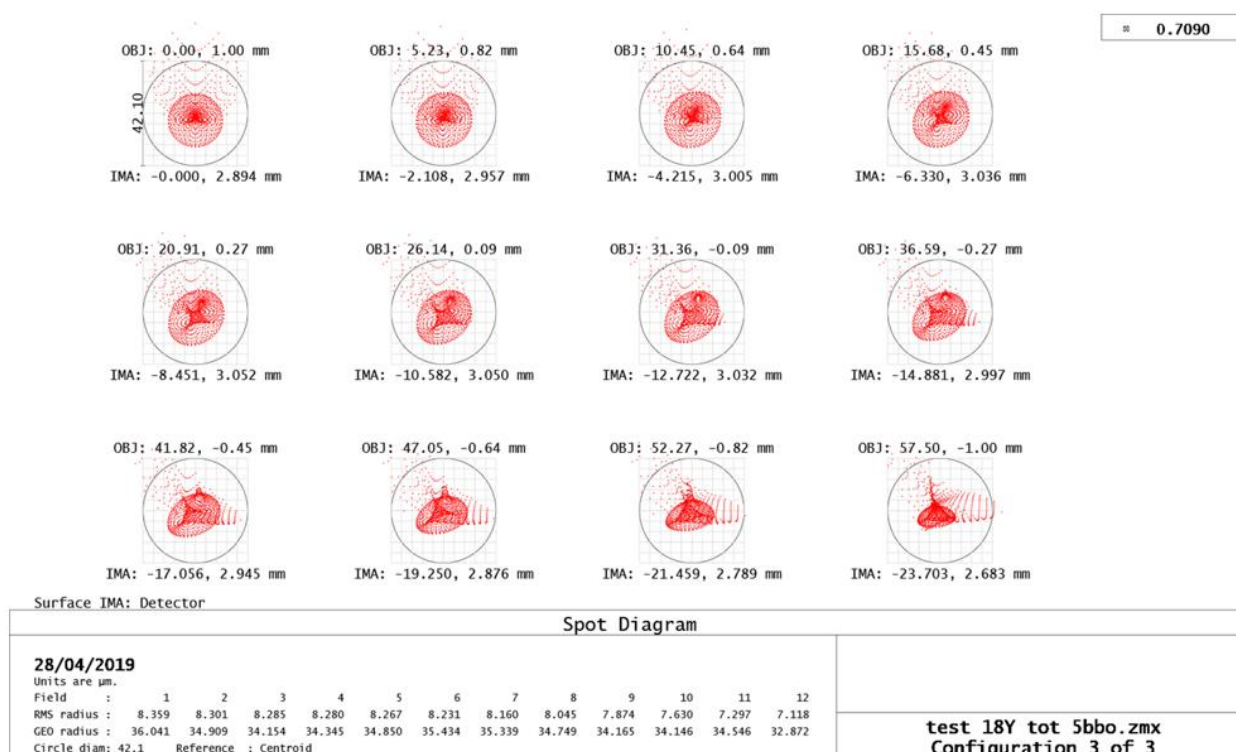

Figure 7. Full field spot diagram for SPH_lite in the middle of the red arm at 709 nm. Circle is fibre core footprint.

3.4 Option 4 – SL

The optical design for the SL option is given in Figure 8, with representative spot diagram given in Figure 9. This option follows the specifications for LUCA, using a single channel with a wavelength range of 360-685nm with the size of the fibre core reduced to 100 μm . The spectrograph is F/3.07 assuming an input beam of F/3.13 blurred by FRD, so faster than Paco Hector. The slit length is the same than Paco Hector.

The image quality is significantly worse than for Paco Hector since the design of LUCA has larger detector image sizes so it can accommodate proportionally worse PSF RMS. Compared to SPH, this reduces the average resolution and increases the variability of PSFs from point to point on the detector. It may also be more sensitive to fibre temperature and pointing variations.

The design of LUCA was made starting with the blue camera of Hector, then the focal ratio was made slightly faster and the wavelength range was increased. The increase in wavelength range happens to be far more problematic than anticipated. This is due to higher order chromatic aberrations. The larger the wavelength range of a camera, the more difficult it is to correct. A change of glasses improved the performance, but this was incomplete. All 3 spherical lenses were made aspheres on one of their surfaces. Even so, PSF and pupil image quality were degraded. The 2-camera DESI design will also require an increase in the wavelength range. It is not clear what the consequences will be on the performances because of the smaller number of parameters that can be adjusted than in the Paco Hector design.

A variant of this option could be considered to further reduce costs, which would reduce the slit length and/or the focal ratio. This would come with an expected reduction in overall efficiency.

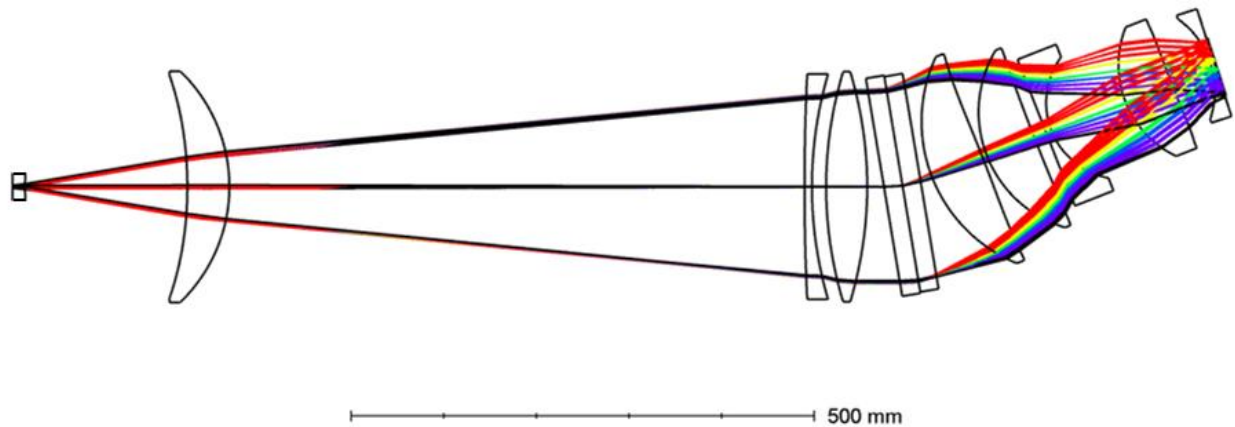

Figure 8. Optical layout for SL.

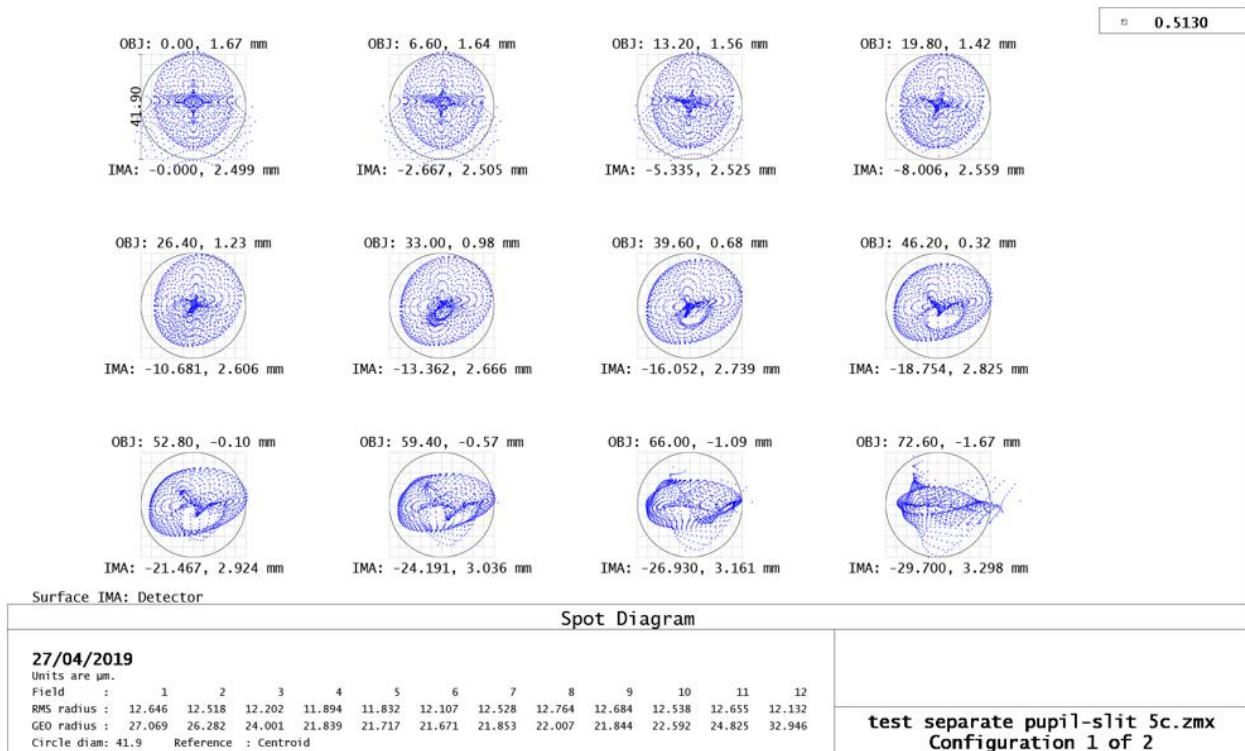

Figure 9. Full field spot diagram for SL in the middle of the single arm at 513 nm. Circle is fibre core footprint.

4 MECHANICAL DESIGN

For each option the mechanical design will follow the approach as for the TAIPAN and Hector spectrographs.

The TAIPAN spectrograph, delivered and installed to the UKST is shown in Figure 10.

The Hector spectrograph mechanical design is shown in Figure 11. Hector is now in fabrication phase and is due for assembly in the next six months.

For both TAIPAN and Hector spectrographs, the detector Dewars are mounted on 5-axis adjustable cradles (Figure 12).

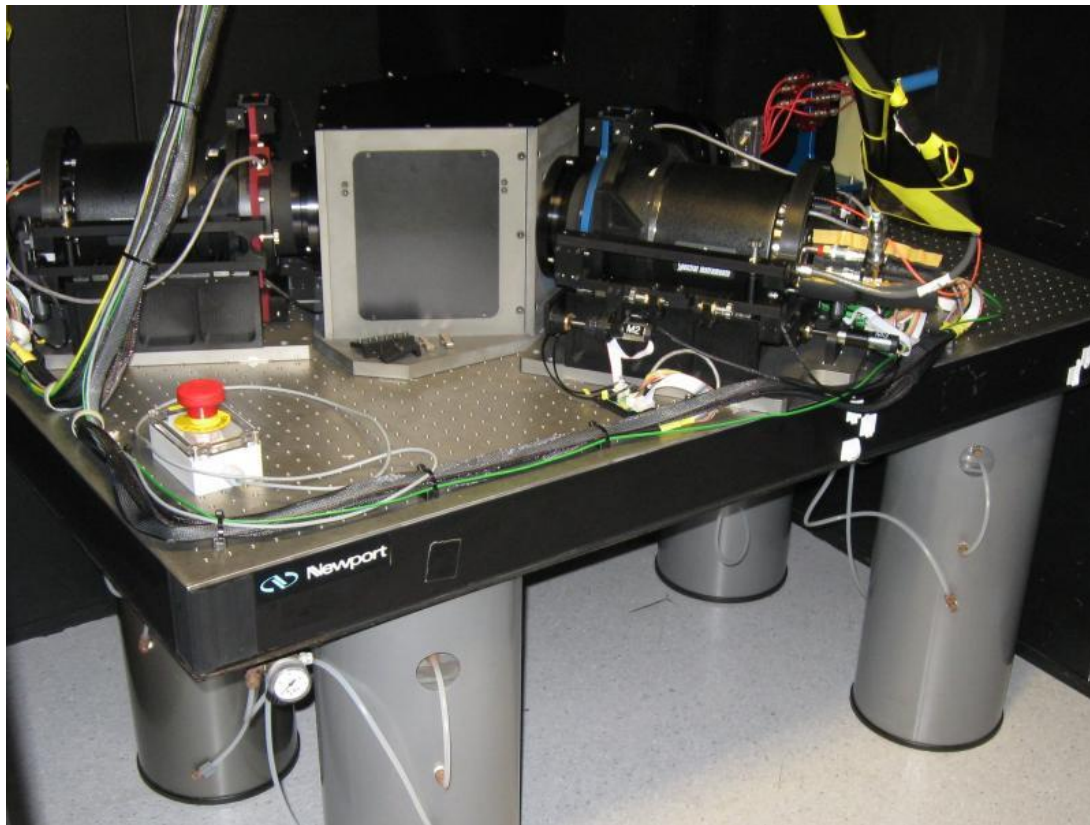

Figure 10. TAIPAN spectrograph installed at the UKST at Siding Spring Observatory.

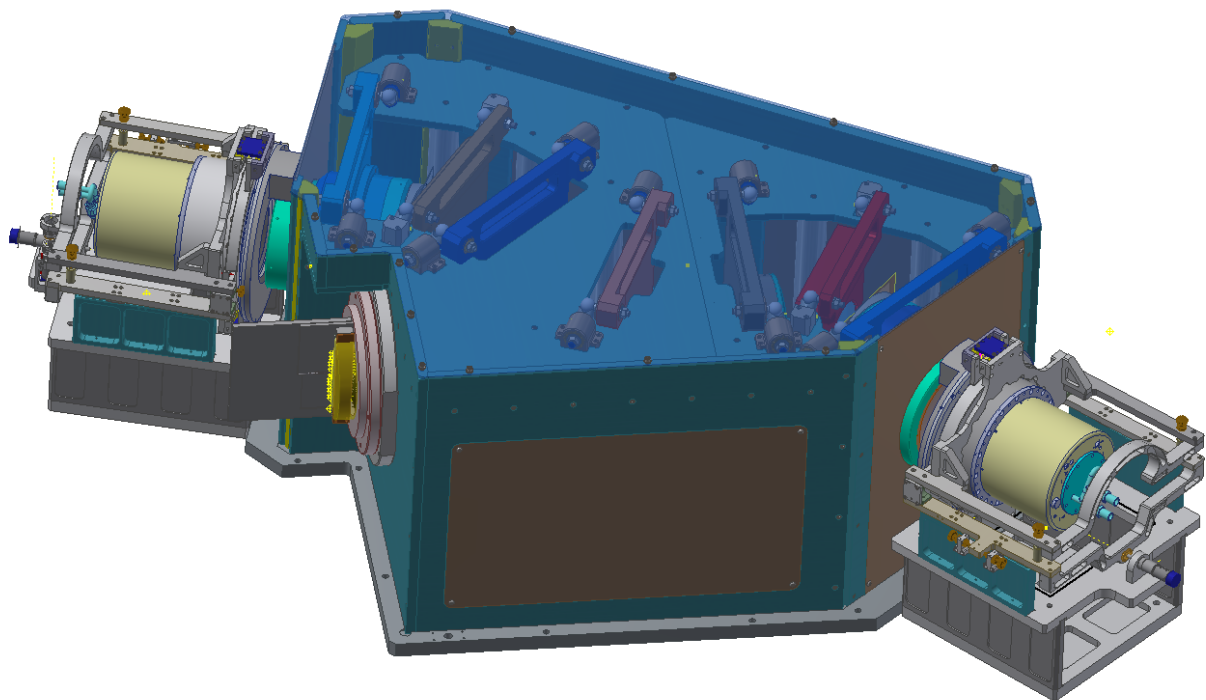

Figure 11. Mechanical design for the Hector spectrograph.

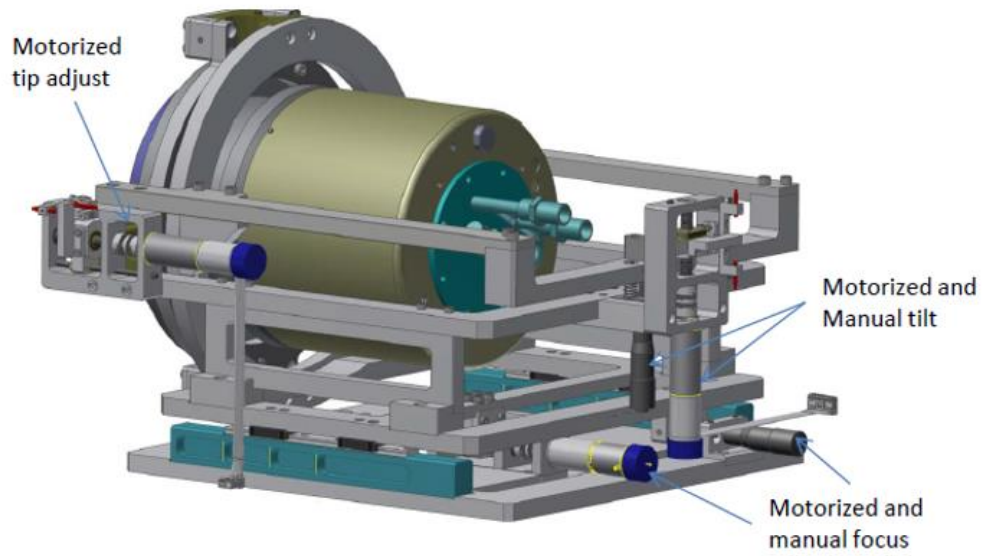

Figure 12. Detector mount cradle design for the Hector spectrograph with 5-axis adjustment.

5 COSTING

For each spectrograph option the costs include:

- All lenses, including slit lenses, collimating and camera lenses and powered cryostat windows;
- Volume phase holographic gratings;
- Dichroic and/or reflective mirror;
- All mechanical mounts, for all lenses and VPHG and dichroic;
- Cradle with 5-axis manual adjustment for the cryostat, with capacity to upgrade to an automatic adjustment;
- All labour associated with design, fabrication, assembly, integration, and testing prior to shipment (noting that tests will be limited without the final cryostats).

Out of scope, un-costed items, include:

- Fibre slits (this is assumed the responsibility of the fibre system fabricator);
- Shutter mechanisms or shutter control mechanisms (to be determined where the shutter is located and if it belongs with the cryostat system as for Hector);
- Shipping, on-telescope installation, integration with the fibre and cryostat subsystems, and assistance with instrument commissioning (these costs can be calculated once the schedule and plan is developed);
- Cryostat and detector sub-systems (noting however, that the last powered spectrograph lens is to be provided as this should be the cryostat window);
- Software or control electronics (noting that the spectrograph is fixed format and thus no motion control system is required).

The cost estimates for each option are given in Table 2. Also provided in the table is the reference cost for the DESI spectrograph baseline (i.e., including only *Winlight System* provided elements without dichroic and VPHG) with optical options (all costs for specification, procurement, assembly, mounts, testing, packaging, and shipping of the VPHG and dichroic and the design, procurement, and assembly of the cryostat adjustable cradles). This reference cost should allow a fair comparison between the designs.

The 4 new spectrograph options presented here are more expensive than the DESI option. This extra expense arises because the AAO-MQ designs do not yet have cost reductions through mass replication of the same lens elements and are not quite at the final design stage. Additionally, there is a difference between the figure of merit, representing the overall power, of the spectrograph design. While it is not strictly a linear relationship between the figure of merit and cost, it is illustrative to compare the cost divided by the figure of merit across the different design options – this is also provided in the cost table.

To proceed to final quote the chosen design should be finalised. This will likely reduce the costs (and also risks) for the project. As noted in sections above, there is scope to make further reductions in the cost for both the SPH_lite and the SL designs, noting that such de-scope would come with an appropriate level of reduction in the overall figure of merit.

Table 2. Cost estimates

Option	Estimate (USD)	Cost estimate/ figure of merit
Reference – DESI baseline with optical options	\$697,848	\$652,195
Option 1 – SPH	\$1,480,000	\$704,762
Option 2 – SPH blue	\$974,000	\$974,000
Option 3 – SPH lite	\$1,003,000	\$771,538
Option 4 – SL	\$1,085,000	\$1,004,630

6 SCHEDULE

A high level estimate for the delivery milestones is provided in Table 3, relative to the milestone start point, T_0 , of finalise optical design. This assumes that a contractual agreement is in place prior to this date. There are still some uncertainties in regards to the timeframe for each phase due to the range of options considered. A detailed project plan and some discussion with glass suppliers will also provide greater certainty.

Table 3. Schedule estimate

Milestone	Due date
Finalise optical design	T_0
Order all optics (lenses/ gratings/ dichroic)	$T_0 + 1-3$ months
Complete mechanical design and release all drawings for manufacture	$T_0 + 10-12$ months
Procurement complete (all optics received and tested, all mechanical parts fabricated)	$T_0 + 15-18$ months
Assembly and test complete (ready for shipping)	$T_0 + 18-24$ months

APPENDIX B



1-arm spectrograph for Schmidt telescope Study and first spectrograph

CAHA

TECHNICAL AND FINANCIAL PROPOSAL Ref. OFWS1840-1-B



1-arm spectrograph for Schmidt telescope Study and first spectrograph CAHA

TECHNICAL AND FINANCIAL PROPOSAL Ref. OFWS1840-1-B



Date : 24 May 2019

	Technical Contact	Commercial Contact
Name :	Vincent Lapère	Philippe Godefroy
Tel. :	+33 (0)4 90 07 78 60	+33 (0)4 90 07 78 60
Fax :	+33 (0)4 90 77 76 31	+33 (0)4 90 77 76 31
Email :	vincent.lapere@winlight-system.com	philippe.godefroy@winlight-system.com

A – TECHNICAL PROPOSAL

1. SUBJECT

This proposal deals with the study and manufacturing of a 1-arm spectrograph for Schmidt spectrograph. The optical design of the spectrograph unit is as shown below. More details are given in the document Ref WS3033-001-RAP001-A (this report refers to IF6000 project for CAHA. It is then IAA responsibility that the 1-arm spectrograph is compatible with the Schmidt telescope).

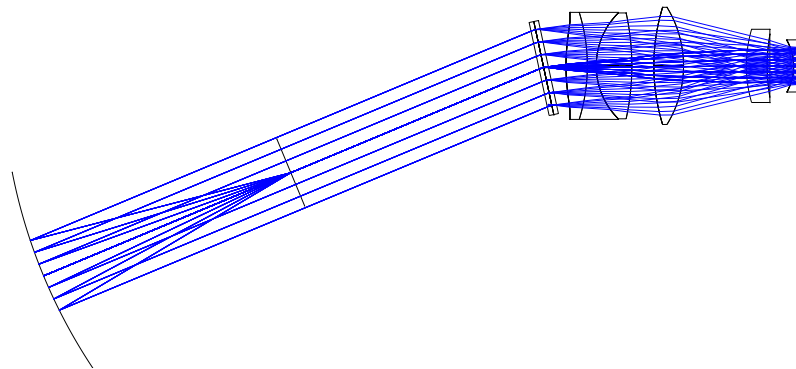

This offer deals with the design and manufacturing of one spectrograph unit.

2. DESCRIPTION OF THE TASKS and DELIVERABLES

a. Optical and mechanical design

The spectrograph design is not a copy of an existing spectrograph. The definition file must be created to allow its manufacturing. During this study some optical and mechanical work is done:

- Optical sensitivity analysis and tolerancing
- Ghost image analysis
- Thermal optical and mechanical analysis
- Mechanical design of the camera assembly, of the grating assembly, of the shutter and cover assembly, and possibly of the collimator assembly (the slit and cryostat assembly are not part of the supply)

Our offer includes:

<i>TASKS TO BE DONE</i>	<i>DELIVERABLES</i>
Optical and mechanical study	Justificative Design Report. Final mechanical design with interfaces CAD model
Final manufacturing drawings	

Our offer does not include:

- Finite Elements Analysis (FEA)
- Thermal impact of the shutter if any
- Everything not specified on “the offer includes”

b. Manufacturing integration and testing

The manufacturing, integration and test of the spectrograph unit will be organized as follows regarding Winlight activities and deliverables:

- Optical manufacturing of the collimator mirror and camera lenses
 - Glass blanks procurement
 - Grinding, polishing of optical elements
 - Coating of elements
- Mechanical pieces procurements
 - Procurement of mechanical pieces
 - Procurement of the shutter (180x180 Bonn)
- Mounting of assemblies :
 - Bench assembly
 - Grating assembly (to be supplied by CAHA)
 - Field lens assembly (with vacuum sealing verification)
 - Camera assembly
 - Shutter and cover assembly
 - Collimator mechanical assembly (without Hartman doors)
- Alignment and tests
 - Alignment of assemblies :
 - Slit interface verification
 - Collimator mirror alignment
 - Grating assembly
 - Camera and field lens assembly

Our offer includes:

<i>TASKS TO BE DONE</i>	<i>DELIVERABLES</i>
Procurement of glass blanks	Certificate of Compliancy
Manufacturing and coating of the lenses	Inspection reports
Manufacturing of mechanical pieces	-
Integration, alignment and testing of the spectrograph assemblies	Inspection report
Delivery of spectrograph packed safely and shipped	Full integrated assemblies on optical bench

Our offer does not include:

- the slit
- the cryostat assembly
- the VPHG
- the Hartmann doors
- final slit mounting and verification are not considered.
- work on or with cryostat is not considered.
- everything not specified on “the offer includes”

Note 1: if parts to be delivered by the project are not delivered in due time (for instance VPHG), Winlight will not be held responsible for delay. In case, this leads to delay the schedule by more than 6 months, Winlight will be allowed to complete its work up to what is possible without this missing part and to invoice the total amount of the contract.

Note 2: as an option, we propose to supply the VPHG grating. Note that we will be able to measure the transmitted wavefront but we do not have the set-up to measure the efficiency.

Note 3: as an option, we propose to supply the Hartmann doors with their electronics.

B – FINANCIAL PROPOSAL

1 - DELIVERY DATE

T0 : date of receipt of the order and/or kick off meeting.

The delivery dates are the followings (August should be neutralized) :

<i>Phase</i>	<i>Delivery time</i>
Study	T0 + 8 months
Glass blank procurement (will start at T0+ 3months)	T1 + 6 months = T0 +9 months
Optical manufacturing (including coating)	T1 + 12 months = T0 + 15 months
Integration, alignment and testing of the spectrograph	T1 + 16 months= T0 + 19 months
Delivery	15 days after acceptance

August has to be neutralized for summer holidays.

2 - PRICES

The tasks as proposed in our technical proposal can be realized for the following amounts:

Item 1 : Optical and mechanical study and non recurrent costs (tooling)

88 000 €

Item 2 : Manufacturing, integration and test of the first spectrograph

273 000 €

Option 1: supply of the VPHG

42 000 €

Option 2: supply of the Hartmann Doors

51 000 €

Our prices are without VAT and DAP your laboratories in Spain.

Item 2 cannot be ordered without Item 1.

Item 2 should be ordered not later than 5 months after Item 1.

3 – SALES CONDITIONS

3.1 - Validity of our offer: our offer is valid 3 months from the date of page 1.

3.2 - Payments schedule: our offer is established taking into account the following payment schedule:

Item 1 :

- 30% with the order
- Balance at delivery

Item 2 :

- 30% with the order
- 30% at glass blanks receipt
- Balance at delivery

3.3 - Way of payment: By bank transfer within 30 days at receipt of the invoice. Initial down payment shall be paid within 10 days after placement of the order. The bank transfer costs remains at your charge. It is not included in our prices charges for the supply of bank guarantee or performance bonds which can be supplied upon request.

3.4 - Guarantee: Our products are guaranteed 12 months. This guarantee is intended for repairs done in our workshop, the packing insurance and transport costs being excluded. The date of the beginning of the guarantee is the date of delivery.

3.5 - Ownership reserve: WINLIGHT SYSTEM keeps the entire ownership of the good until the effective payment of the total price amount. The non-payment of any expired date can involve the claim of the goods. These clauses do not obstruct the transfer to the buyer, from delivery, of losses or damage risk on the sold goods as well as damages they could induce.

3.6 - Limit of responsibility : our products are manufactured according state of the art techniques. Therefore, we cannot be held responsible for any consequences caused by either delay or failure of our products.

Philippe Godefroy

C.O.O.